

COMMERCIAL ELECTRIC WATER HEATERS



www.statewaterheaters.com



MODELS SSE-5 THRU SSE-120
INSTALLATION - OPERATION - SERVICE -
MAINTENANCE - LIMITED WARRANTY



Thank you for buying this energy efficient water heater. We appreciate your confidence in our products.



⚠ WARNING

Read and understand this instruction manual and the safety messages herein before installing, operating, or servicing this water heater.

Failure to follow these instructions and safety messages could result in death or serious injury.

This manual must remain with the water heater.

⚠ WARNING

If the heater becomes immersed in water up to or above the level of the bottom of the element doors, the heater should be examined by a qualified service agency before it is placed in operation, see Page 2.



PLACE THESE INSTRUCTIONS ADJACENT TO HEATER AND NOTIFY OWNER TO KEEP FOR FUTURE REFERENCE.

SAFE INSTALLATION, USE AND SERVICE

Your safety and the safety of others is extremely important in the installation, use, and servicing of this water heater.

Many safety-related messages and instructions have been provided in this manual and on your own water heater to warn you and others of a potential injury hazard. Read and obey all safety messages and instructions throughout this manual. It is very important that the meaning of each safety message is understood by you and others who install, use, or service this water heater.

	<p>This is the safety alert symbol. It is used to alert you to potential personal injury hazards. Obey all safety messages that follow this symbol to avoid possible injury or death.</p>
-----------------------------------------------------------------------------------	-------------------------------------------------------------------------------------------------------------------------------------------------------------------------------------------

	<p>DANGER indicates an imminently hazardous situation which, if not avoided, will result in death or injury.</p>
	<p>WARNING indicates a potentially hazardous situation which, if not avoided, could result in death or injury.</p>
	<p>CAUTION indicates a potentially hazardous situation which, if not avoided, could result in minor or moderate injury.</p>
<p>CAUTION</p>	<p>CAUTION used without the safety alert symbol indicates a potentially hazardous situation which, if not avoided, could result in property damage.</p>

All safety messages will generally tell you about the type of hazard, what can happen if you do not follow the safety message, and how to avoid the risk of injury.

The California Safe Drinking Water and Toxic Enforcement Act requires the Governor of California to publish a list of substances known to the State of California to cause cancer, birth defects, or other reproductive harm, and requires businesses to warn of potential exposure to such substances.

This product contains a chemical known to the State of California to cause cancer, birth defects, or other reproductive harm. This water heater can cause low level exposure to some of the substances, included in the act.

IMPORTANT DEFINITIONS

- **Qualified Installer or Service Agency:**

Installation and service of this water heater requires ability equivalent to that of a Qualified Agency (as defined by ANSI below) in the field involved. Installation skills such as plumbing and electrical supply are required in addition to electrical testing skills when performing service.

- **ANSI Z223.1 2006 Sec. 3.3.83:**

“Qualified Agency” - “Any individual, firm, corporation or company that either in person or through a representative is engaged in and is responsible for (a) the installation, testing or replacement of gas piping or (b) the connection, installation, testing, repair or servicing of appliances and equipment; that is experienced in such work; that is familiar with all precautions required; and that has complied with all the requirements of the authority having jurisdiction.”

GENERAL SAFETY INFORMATION

PRECAUTIONS

DO NOT USE THIS WATER HEATER IF ANY PART HAS BEEN UNDER WATER. Immediately call a qualified service technician to inspect the water heater and to replace any part of the control system which has been under water.

If the unit is exposed to the following, do not operate heater until all corrective steps have been made by a qualified service agency.

1. External fire.
2. Damage.
3. Firing without water.

GROUNDING INSTRUCTIONS

This water heater must be grounded in accordance with the National Electrical Code and/or local codes. These must be followed in all cases. Failure to ground this water heater properly may also cause erratic control system operation on ELECTRONIC CONTROL models.

This water heater must be connected to a grounded metal, permanent wiring system, or an equipment grounding conductor must be run with the circuit conductors and connected to the equipment grounding terminal or lead on the water heater.

HYDROGEN GAS (FLAMMABLE)

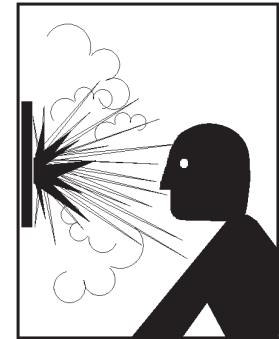
	⚠ WARNING
	Explosion Hazard <ul style="list-style-type: none">• Flammable hydrogen gases may be present.• Keep all ignition sources away from faucet when turning on hot water.

Hydrogen gas can be produced in a hot water system served by this heater that has not been used for a long period of time (generally two weeks or more). Hydrogen gas is extremely flammable. To reduce the risk of injury under these conditions, it is recommended that the hot water faucet be opened for several minutes at the kitchen sink before using any electrical appliance connected to the hot water system. If hydrogen is present there will probably be an unusual sound such as air escaping through the pipe as the water begins to flow. THERE SHOULD BE NO SMOKING OR OPEN FLAME NEAR THE FAUCET AT THE TIME IT IS OPEN.

When servicing this unit, verify the power to the unit is turned off prior to opening the control cabinet door.

	⚠ WARNING
	Read and understand this instruction manual and the safety messages herein before installing, operating, or servicing this water heater. Failure to follow these instructions and safety messages could result in death or serious injury. This manual must remain with the water heater.

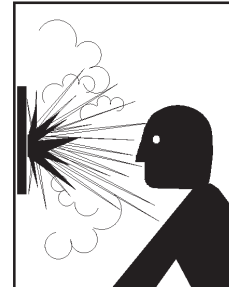
	⚠ WARNING
	Explosion Hazard <ul style="list-style-type: none">• Flammable hydrogen gases may be present.• Keep all ignition sources away from faucet when turning on hot water.

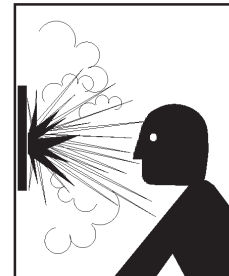
	⚠ WARNING
	Explosion Hazard <ul style="list-style-type: none">• Overheated water can cause watertank explosion.• Properly sized temperature and pressure relief valve must be installed in opening provided.

	⚠ WARNING
	<ul style="list-style-type: none">• Before removing any access panels or servicing the water heater, make sure the electrical supply to the water heater is turned "OFF."• Failure to do this could result in death, serious bodily injury, or property damage.

CAUTION
Improper Installation, use and service may result in property damage.
<ul style="list-style-type: none">• Do not operate water heater if flood damaged.• Inspect anode rods regularly, replace when significantly depleted.• Install in location with drainage.• Fill tank with water before operation.• Properly sized thermal expansion tanks are required on all closed water systems. Refer to this manual for installation and service.

⚠ DANGER	Water temperature over 125°F (52°C) can cause severe burns instantly resulting in severe injury or death. Children, the elderly, and the physically or mentally disabled are at highest risk for scald injury. Feel water before bathing or showering. Temperature limiting valves are available. Read instruction manual for safe temperature setting.
	

TABLE OF CONTENTS

SAFE INSTALLATION, USE AND SERVICE.....	2	High Temperature Limit Controls (ECO).....	16
GENERAL SAFETY INFORMATION.....	3	Thermostat Controls.....	16
Precautions.....	3	Temperature Adjustment.....	16
Hydrogen Gas (Flammable).....	3	CONTROL SYSTEM OPERATION.....	17
INTRODUCTION.....	4	Heating Element Operation.....	17
Preparing for the Installation.....	4	Control System Features.....	17
DIMENSIONS AND CAPACITIES DATA.....	5	Control System Navigation.....	17
FEATURES AND COMPONENTS.....	6	The Desktop Screen.....	17
APPROVALS.....	7	Temperatures Menu.....	20
MODEL AND RATING.....	7	Heater Status Menu.....	22
LOCATING THE NEW WATER HEATER.....	7	Economy Mode Setup Menu.....	22
Facts to Consider About the Location.....	7	Economy Mode Settings.....	24
INSTALLATION.....	8	Alarm Output Setup Menu.....	27
Required Ability.....	8	Display Settings Menu.....	27
General.....	8	Heater Information Menu.....	27
Contaminated Water.....	8	Current Fault / Alert Menu.....	28
Circulating Pump.....	8	Fault History Menu.....	28
Temperature-Pressure Relief Valve.....	8	Fault Occurrence Menu.....	28
Water Line Connections.....	9	Restore Factory Defaults Menu.....	29
Closed Water Systems.....	9	MAINTENANCE.....	30
Thermal Expansion.....	9	General.....	30
ELECTRICAL DATA.....	10	Anode Inspection and Replacement.....	30
General.....	10	Temperature-Pressure Relief Valve Operation.....	30
Branch Circuit.....	10	Flushing.....	30
Heater Circuits.....	10	Sediment Removal.....	30
Control Circuits.....	10	Lime Scale Removal.....	30
Power Circuit.....	10	TROUBLESHOOTING CHECKLIST.....	32
WIRING DIAGRAMS.....	12	Not Enough or No Hot Water.....	32
OPERATION.....	15	Water Is Too Hot.....	32
General.....	15	Water Heater Makes Strange Sounds.....	32
Filling the Water Heater.....	15	Leakage Checkpoints.....	32
Initial Start Up.....	15	PIPING DIAGRAMS.....	33
Draining the Water Heater.....	15	NOTES.....	45
TEMPERATURE REGULATION.....	16	WARRANTY.....	47

INTRODUCTION

Thank You for purchasing this water heater. Properly installed and maintained, it should give you years of trouble free service.

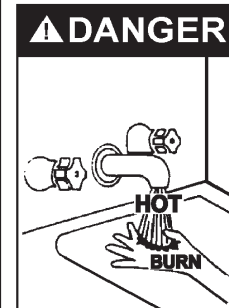
Abbreviations Found In This Instruction Manual:

- ANSI - American National Standards Institute
- ASME - American Society of Mechanical Engineers
- AHRI - Air-Conditioning, Heating and Refrigeration Institute
- NEC - National Electrical Code
- NFPA - National Fire Protection Association
- UL - Underwriters Laboratory

PREPARING FOR THE INSTALLATION

1. Read the "General Safety" section of this manual first and then the entire manual carefully. If you don't follow the safety rules, the water heater may not operate safely. It could cause DEATH, SERIOUS BODILY INJURY AND/OR PROPERTY DAMAGE.

This manual contains instructions for the installation, operation, and maintenance of the electric water heater. It also contains warnings throughout the manual that you must read and be aware of. All warnings and all instructions are essential to the proper operation of the water heater and your safety. READ THE ENTIRE MANUAL BEFORE ATTEMPTING TO INSTALL OR OPERATE THE WATER HEATER.

Detailed installation diagrams are in this manual. These diagrams will serve to provide the installer with a reference for the materials and method of piping suggested. IT IS NECESSARY THAT ALL WATER PIPING AND THE ELECTRICAL WIRING BE INSTALLED AND CONNECTED AS SHOWN IN THE DIAGRAMS.

Particular attention should be given to the installation of thermometers at the locations indicated in the diagrams as these are necessary for checking the operation of the heater.

Be sure to turn off power when working on or near the electrical system of the heater. Never touch electrical components with wet hands or when standing in water. When replacing

fuses always use the correct size for the circuit. See page 12 through 14.

The principal components of the heater are identified on page 6. The model and rating plate on page 7 interprets certain markings into useful information. Both of these references should be used to identify the heater, its components and optional equipment.

2. The installation must conform with these instructions and the local code authority having jurisdiction and the requirements of the power company. In the absence of code requirements, follow NFPA-70 (current edition). The National Electrical Code may be ordered from: National Fire Protection Association, 1 Batterymarch Park, Quincy, MA 02269.
3. If after reading this manual you have any questions or do not understand any portion of the instructions, call the toll free number on the back cover for further assistance.

A sample rating plate and barcode tag are shown on page 3 of this manual. In order to expedite your request, please have the serial number and item ID from the barcode tag available for the technician.

4. Carefully plan your intended placement of the water heater. Examine the location to ensure the water heater complies with the "Locating the New Water Heater" section in this manual.

Installation and service of this water heater requires ability equivalent to that of a licensed tradesman or qualified agency (page 2) in the field involved. Plumbing and electrical work are required.

5. For installation in California this water heater must be braced or anchored to avoid falling or moving during an earthquake. See instructions for correct installation procedures. Instructions may be obtained from California Office of the State Architect, 1102 Q Street, Suite 5100, Sacramento, CA 95811.
6. Massachusetts Code requires this water heater to be installed in accordance with Massachusetts 248-CMR 2.00: State Plumbing Code and 248-CMR 5.00.

DIMENSIONS AND CAPACITIES DATA

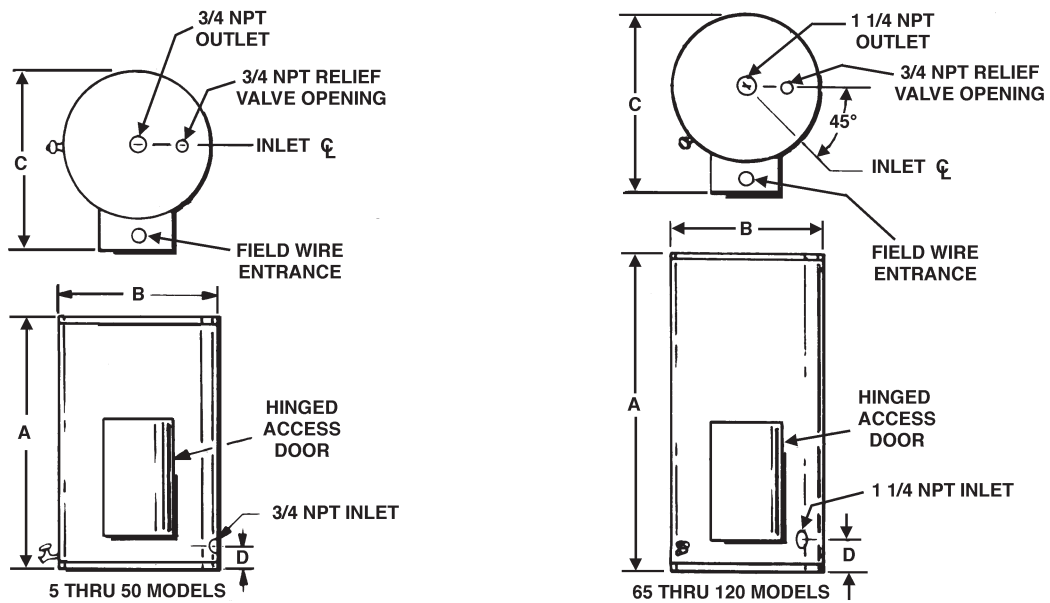

FIGURE 1.

TABLE 1.

Tank Capacity		Maximum KW Input	All Dimensions in Inches (mm)								Approximate Shipping Wt.	
Gallons	Liters		A		B		C		D		Lbs.	Kg.
5	19	3	20 1/2	521 mm	16 1/4	412.75 mm	22 1/2	571.5 mm	5 1/4	133.35 mm	82	37.2
10	38	6	26 1/4	667 mm	18 3/4	476.25 mm	25	635 mm	5 1/4	133.35 mm	106	48.1
20	76	18	27 1/4	692 mm	20 1/2	520.7 mm	26 1/2	673.1 mm	5 3/4	146.05 mm	130	59
30	114	24	35 3/4	908 mm	20 1/2	520.7 mm	26 1/2	673.1 mm	5 3/4	146.05 mm	150	68
40	151	36	45 3/4	1,162 mm	20 1/2	520.7 mm	26 1/2	673.1 mm	5 3/4	146.05 mm	190	86.2
50	189	90	54 3/4	1,391 mm	20 1/2	520.7 mm	26 1/2	673.1 mm	5 3/4	146.05 mm	221	100.2
65	246	90	50 1/2	1,283 mm	26 1/2	673.1 mm	33 1/2	850.9 mm	7	177.8 mm	267	121.1
80	303	90	49 1/4	1,251 mm	28	711.2 mm	35	889 mm	7	177.8 mm	285	129.3
100	379	90	58 1/4	1,480 mm	28	711.2 mm	35	889 mm	7	177.8 mm	354	160.6
120	450	90	63 1/4	1,607 mm	30	762 mm	37	939.8 mm	7 1/2	190.5 mm	420	190.5

TABLE 2.

RECOVERY RATE IN GALLONS PER HOUR *
Temperature Rise °F

STANDARD KW INPUT	BTU/ HOUR	30°	40°	50°	60°	70°	80°	90°	100°	110°	120°	130°	140°
3	10,239	41	31	24	20	17	15	13	12	11	10	10	9
6	20,478	82	62	49	41	35	31	27	25	22	21	19	18
9	30,717	123	92	74	62	53	46	41	37	34	31	28	26
12	40,956	164	123	98	82	70	61	55	49	45	41	38	35
15	51,195	205	154	123	102	88	77	68	61	56	51	47	44
18	61,434	246	184	148	123	105	92	82	74	67	62	57	53
24	81,912	328	246	197	164	140	123	109	98	90	82	76	70
30	102,390	410	308	246	205	176	154	137	123	112	103	95	88
36	122,868	492	369	295	246	211	184	164	148	134	123	113	105
45	153,585	615	461	369	307	263	230	205	184	168	154	142	132
54	184,302	738	554	443	359	316	277	246	221	201	185	170	158
60	204,780	819	615	492	410	351	307	273	246	223	205	189	176
75	255,975	1025	768	615	512	439	384	341	307	279	256	236	219
90	307,170	1229	922	738	615	527	461	410	369	335	307	284	263

FEATURES AND COMPONENTS

Below is an illustration of the water heater with its features called out. The text of this manual will refer to the items shown.

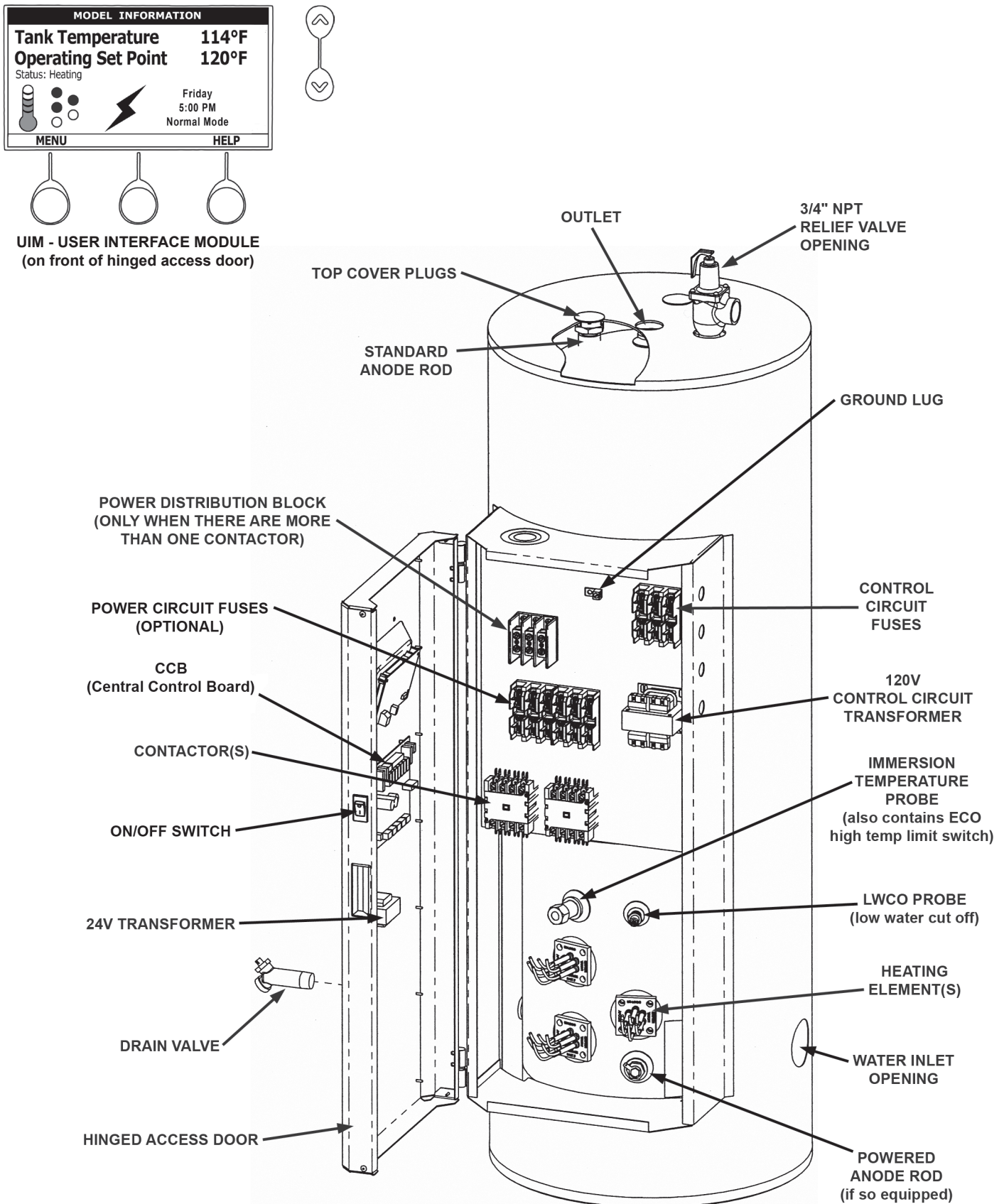

FIGURE 2.

APPROVALS

All models meet National Sanitation Foundation NSF-5 requirements.



All models are listed by Underwriters Laboratories Inc.



Low Lead Content

MODEL AND RATING



09642518
model #: 18 DIGIT MODEL NO.
item id: XXXXXXXXXX
serial #: J07R000385
lot: 3 gas type: 0

		AUTOMATIC ELECTRIC WATER HEATER	
LISTED 709T		Complies with current edition of ASHRAE / IESNA 90.1	LLC
MODEL NUMBER	SERIAL NUMBER	ITEM ID	
PHASE	HZ	AMPERES	VOLTS AC
			No. OF ELEMENTS
			WATTS EACH
			WATTS TOTAL
USE ON A.C. CURRENT ONLY			
CAPACITY US GAL RATED	STANDBY LOSS %	MAX WORKING WATTS	PRESSURE
<small>FOR SUPPLY CONNECTION USE WIRE SUITABLE FOR AT LEAST 90° C</small>			

LOCATING THE NEW WATER HEATER

FACTS TO CONSIDER ABOUT THE LOCATION

CAUTION

Property Damage Hazard

- All water heaters eventually leak
- Do not install without adequate drainage.

Carefully choose a location for the new water heater. The placement is a very important consideration for the safety of the occupants in the building and for the most economical use of the water heater.

Whether replacing an old water heater or putting the water heater in a new location, the following critical points must be observed. The water heater must be located:

1. On a level surface. Shim the channel type skid base as necessary if levelling is required.

2. Near a floor drain. The heater should be located in an area where leakage of the tank or connections will not result in damage to the area adjacent to the heater or to lower floors of the structure.
3. The discharge opening of the temperature and pressure relief valve should always be piped to an open drain or external to the building.
4. Close to the point of major hot water usage and the power supply.

Hot water piping and branch circuit wiring should be as short as possible.

Insulate hot and cold water piping where heat loss and condensation may be a problem.

Heater construction permits installation, maintenance, and service work to be performed through the front control panel.

Suggested clearances from adjacent surfaces are 12 inches on top, 30 inches in front for access to the unit.

The heater may be installed on or against combustible surfaces. The left side and back may be placed flush against adjacent surfaces.

The temperature of the space in which the water heater is installed must not go below 32°F or above 122°F.

INSTALLATION

REQUIRED ABILITY

Installation and service of this water heater requires ability equivalent to that of a qualified agency (page 2) in the field involved. Plumbing and electrical work is required.

GENERAL

The installation must conform with these instructions and the local code authority having jurisdiction and the requirements of the power company. In the absence of local codes, the installation must comply with the current editions of the National Electrical Code, NFPA 70 or the Canadian Electrical Code CSA C22.1. The National Electrical Code may be ordered from: National Fire Protection Association, 1 Batterymarch Park, Quincy, MA 02269. The Canadian Electrical Code is available from the Canadian Standards Association, 8501 East Pleasant Valley Road, Cleveland, OH 44131.

Note: To comply with NSF Standard 5 installation requirements the bottom of the water heater must be sealed to the floor with a silicone based sealant or elevated 6 inches above the floor.

Do **NOT** test electrical system before heater is filled with water, follow the START UP procedure in the OPERATION section of this manual.

The principal components of the heater are identified in the Features and Components illustration in Figure 2.

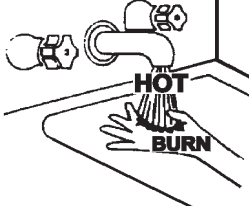
 DANGER	Water temperature over 125°F (52°C) can cause severe burns instantly resulting in severe injury or death. Children, the elderly, and the physically or mentally disabled are at highest risk for scald injury. Feel water before bathing or showering. Temperature limiting valves are available. Read instruction manual for safe temperature setting.
	

MIXING VALVE USAGE:

Water heaters are intended to produce hot water. Water heated to a temperature which will satisfy space heating, clothes washing, dish washing, cleaning and other sanitizing needs can scald and permanently injure you upon contact. Some people are more likely to be permanently injured by hot water than others. These include the elderly, children, the infirm, or physically/developmentally disabled. If anyone using hot water in your home fits into one of these groups or if there is a local code or state law requiring a maximum water temperature at the hot water tap, then you must take special precautions. In addition to using the lowest possible temperature setting that satisfies your hot water needs, a means such as a **MIXING VALVE** should be used at the hot water taps used by these people or at the water heater.

MIXING VALVES for reducing point of use temperature are available. Consult a qualified installer or service agency. Follow all manufacturer's Instructions for installation of these valves. Before changing the factory setting on the thermostat, read the "Temperature Regulation" section in this manual.

 WARNING
Toxic Chemical Hazard
• Do not connect to non-potable water system.

CONTAMINATED WATER

This water heater shall not be connected to any heating system(s) or component(s) used with a non-potable water heating appliance.

Toxic chemicals, such as those used for boiler treatment shall not be introduced into this system.

Products of this sort should not be stored near the heater. Also, air which is brought in contact with the water heater should not contain any of these chemicals. If necessary, uncontaminated air should be obtained from remote or outside sources.

CIRCULATING PUMP

Field installed circulating pumps should be of all bronze construction.

TEMPERATURE-PRESSURE RELIEF VALVE

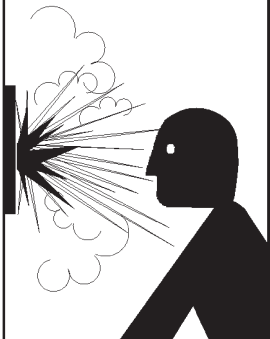
 WARNING	Explosion Hazard
	<ul style="list-style-type: none">• Temperature-pressure relief valve must comply with ANSI Z21.22 and ASME code.• Properly sized temperature-relief valve must be installed in opening provided.• Failure to install relief valve can result in overheating and excessive tank pressure.• Failure to follow these instructions can cause serious injury or death.

This water heater is provided with a properly rated/sized and certified combination temperature - pressure relief valve by the 11 manufacturer. The valve is certified by a nationally recognized testing laboratory that maintains periodic inspection of production of listed equipment of materials as meeting the requirements for Relief Valves for Hot Water Supply Systems, ANSI Z21.22 • CSA 4.4, and the code requirements of ASME.

If replaced, the new valve must meet the requirements of local codes, but not less than a combination temperature and pressure relief valve rated/sized and certified as indicated in the above paragraph. The new valve must be marked with a maximum set pressure not to exceed the marked hydrostatic working pressure of the water heater (150 psi = 1,035 kPa) and a discharge capacity not less than the water heater Btu/hr or KW input rate as shown on the water heater's model rating plate.

For safe operation of the water heater, the temperature and pressure relief valve must not be removed from its designated opening nor plugged. The temperature-pressure relief valve must be installed directly into the fitting of the water heater designed for the relief valve. Install discharge piping so that any discharge will exit only within 6 inches (15.2 cm) above, or at any distance below the structural floor. Be certain that no contact is made with any live electrical part. The discharge opening must not be blocked or reduced in size under any circumstances. Excessive length, over 30 feet (9.14 m), or use of more than four elbows can cause restriction and reduce the discharge capacity of the valve.

No valve or other obstruction is to be placed between the relief valve and the tank. Do not connect discharge piping directly to the drain unless a 6" (15.2 cm) air gap is provided. To prevent bodily injury, hazard to life, or property damage, the relief valve must be allowed to discharge water in adequate quantities should circumstances demand. If the discharge pipe is not connected to a drain or other suitable means, the water flow may cause property damage.

CAUTION
Water Damage Hazard
<ul style="list-style-type: none"> • Temperature-pressure relief valve discharge pipe must terminate at adequate drain.

The Discharge Pipe:

- Shall not be smaller in size than the outlet pipe size of the valve, or have any reducing couplings or other restrictions.
- Shall not be plugged or blocked.
- Shall be of material listed for hot water distribution.
- Shall be installed so as to allow complete drainage of both the temperature-pressure relief valve and the discharge pipe.
- Shall terminate a maximum of six inches above a floor drain or external to the building. In cold climates, it is recommended that the discharge pipe be terminated at an adequate drain inside the building.
- Shall not have any valve or other obstruction between the relief valve and the drain.

The temperature-pressure relief valve must be manually operated at least once a year. Caution should be taken to ensure that (1) no one is in front of or around the outlet of the temperature-pressure relief valve discharge line, and (2) the water manually discharged will not cause any bodily injury or property damage because the water may be extremely hot. If after manually operating the valve, it fails to completely reset and continues to release water, immediately close the cold water inlet to the water heater, follow the draining instructions in this manual, and replace the temperature-pressure relief valve with a properly rated/sized new one.

If you do not understand these instructions or have any questions regarding the temperature-pressure relief valve call the toll free number listed on the back cover of this manual for technical assistance.

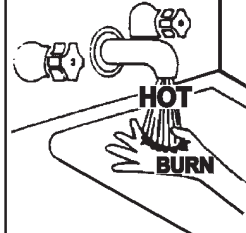
▲ DANGER	<p>Water temperature over 125°F (52°C) can cause severe burns instantly resulting in severe injury or death.</p> <p>Children, the elderly, and the physically or mentally disabled are at highest risk for scald injury.</p> <p>Feel water before bathing or showering.</p> <p>Temperature limiting valves are available.</p> <p>Read instruction manual for safe temperature setting.</p>
	

Once the water heater is installed and filled with water, check the operation of the temperature-pressure relief valve. Follow the instructions in the Maintenance section of this manual.

WATER LINE CONNECTIONS

This manual provides detailed piping installation diagrams (see back section of this manual) for typical methods of application. For the heater inlet and outlet connections, di-electric unions are recommended. The water heater may be installed by itself, or with a separate storage tank, on both single and two-temperature systems. When used with a separate storage tank, the circulation may be either by gravity or by means of a circulating pump. When a circulating pump is used it is important to note that the flow rate should be slow so that there will be a minimum of turbulence inside the heater.

CLOSED WATER SYSTEMS

Water supply systems may, because of code requirements or such conditions as high line pressure, among others, have installed devices such as pressure reducing valves, check valves, and back flow preventers. Devices such as these cause the water system to be a closed system.

THERMAL EXPANSION

As water is heated, it expands (thermal expansion). In a closed system the volume of water will grow when it is heated. As the volume of water grows there will be a corresponding increase in water pressure due to thermal expansion. Thermal expansion can cause premature tank failure (leakage). This type of failure is not covered under the limited warranty. Thermal expansion can also cause intermittent temperature pressure relief valve operation: water discharged from the valve due to excessive pressure build up. This condition is not covered under the limited warranty. The temperature-pressure relief valve is not intended for the constant relief of thermal expansion.

A properly sized thermal expansion tank should be installed on all closed systems to control the harmful effects of thermal expansion. Contact a local plumbing service agency to have a thermal expansion tank installed.

ELECTRICAL DATA

GENERAL

Check the water heater model and rating plate information against the characteristics of the branch circuit electrical supply. Do not connect the heater to an improper source of electricity.

Voltage applied to the heater should not vary more than +5% to -10% of the model and rating plate marking for satisfactory operation.

Do NOT energize the branch circuit for any reason before the water heater tank is filled with water. Doing so may cause the heating elements to fail.

The installation must conform to these instructions and the local code authority having jurisdiction. Grounding and electrical wiring connected to the water heater must also conform to the National Electrical Code, NFPA 70. This publication is available from The National Fire Protection Association, 1 Batterymarch Park, Quincy, MA 02269.

BRANCH CIRCUIT

The branch circuit wire size should be established through reference to the NEC (National Electrical Code) or other locally approved sources in conjunction with the water heater amperage rating. Wire rated at 75°C should be used. For convenience, portions of the wire size tables from the Code are reproduced in Table 3. It is suggested the electrician size the branch circuit at 125 percent of the heater rating and further increase wire size as necessary to compensate for voltage drop in long runs. Voltage drop should not exceed 3% at the water heater.

HEATER CIRCUITS

The water heater's electrical components are pictured and identified in the Features and Components illustrations in Figure 2. The model and rating plate provides heater circuit ratings. There are two main electrical circuits:

Control Circuit: Power supply for the electromagnetic contactor coils. 120V power is supplied to the contactor coils by the CCB (Central Control Board) see wiring diagrams in this manual.

Power Circuit: High voltage, single or three phase, circuit that carries the heating element load.

The following section and pages describe the water heater circuits and includes wiring diagrams.

CONTROL CIRCUITS

The water heater is equipped with an electronic control system. The system includes a CCB (Central Control Board), an immersion temperature probe with ECO for temperature sensing and limiting, a UIM (User Interface Module) for user interface & information display and element current sensors for monitoring the power circuits. Refer to the control circuit label on the water heater for details. The CCB is powered by a small 120V/24V transformer. The control circuit operates on 120V supplied by a larger 100VA transformer.

Sequence of Operation

1. When the control is powered, the UIM should display model information, water temperature, operating setpoint, heating status and operating mode.
2. If the control determines that the actual water temperature inside the tank is below the programmed operating setpoint minus the (1st) differential setpoint, a call for heat is activated.
3. After all safety checks are verified the CCB will energize the contactor coil(s). On models with more than one heating element the upper most heating elements are energized first. Successive heating elements are energized according to programmed differential setpoints for each heating element.
4. The control remains in the heating mode until the water temperature reaches the programmed operating setpoint. At this point the contactors will be de-energized.
5. The control system now enters the standby operating mode while continuing to monitor the water temperature and the state of other system devices. If the water temperature drops below the programmed Operating Setpoint minus the (1st) differential setpoint, the control will automatically return to step 2 and repeat the heating cycle.

POWER CIRCUIT

Power circuit wiring is type THHN (or equivalent) rated 600 volts, 105°C, sized as necessary.

The following wiring diagrams are included in this manual to show typical arrangements of electrical components in the control and power circuits by voltage and phase characteristics. They are to be used as a reference by the installer or servicer in performing their work. An actual diagram of the water heater wiring is furnished with the heater.

TABLE 3.

Allowable Ampacities of Insulated Conductors

Not More Than Three Conductors in Raceway or Cable or Earth (Directly Buried), Based on Ambient Temperature of 30°C (86°F)

Size	Temperature Rating of Conductor								Size
	60°C (140°F)	75°C (167°F)	85°C (185°F)	90°C (194°F)	60°C (140°F)	75°C (167°F)	85°C (185°F)	90°C (194°F)	
AWG	TYPES RUW, T TW, UF	TYPES FEPW RH, RHW RUH, THW, THWN, XHHW USE, ZW	TYPES V, MI	TYPES TA, TBS SA, AVB SIS, =FEP, =FEPB, =RHH, =THHN, =XHHW*	TYPES RUW, T TW, UF	TYPES RH, RHW RUH THW, THWN, XHHW, USE	TYPES V, MI	TYPES TA, TBS, SA, AVB SIS, =RHH, =THHN, =XHHW*	AWG
MCM									MCM
COPPER					ALUMINUM OR COPPER-CLAD ALUMINUM				
18	21
16	22	22
14	15	15	25	25
12	20	20	30	30	15	15	25	25	12
10	30	30	40	40	25	25	30	30	10
8	40	45	50	50	30	40	40	40	8
6	55	65	70	70	40	50	55	55	6
4	70	85	90	90	55	65	70	70	4
3	80	100	105	105	65	75	80	80	3
2		115	120	120	75	90	95	95	2
1		130	140	140		100	110	110	1
0		150	155	155		120	125	125	0
00		175	185	185		135	145	145	00
000		200	210	210		155	165	165	000
0000		230	235	235		180	185	185	0000
250		255	270	270		205	215	215	250
300		285	300	300		230	240	240	300
350		310	325	325		250	260	260	350
400		335	360	360		270	290	290	400
500		380	405	405		310	330	330	500
CORRECTION FACTORS									
Ambient Temperature °C	For ambient temperatures over 30°C, multiply the ampacities shown by the appropriate correction factor to determine the maximum allowable load current.								Ambient Temperature °F
31-40	.82	.88	.90	.91	.82	.88	.90	.91	86-104
41-50	.58	.75	.80	.82	.58	.75	.80	.82	105-122
51-6058	.67	.7158	.67	.71	123-141
61-7035	.52	.5835	.52	.58	142-158
71-8030	.4130	.41	159-176

= The load current rating and the overcurrent protection for these conductors shall not exceed 15 amperes for 14 AWG, 20 amperes for 12 AWG, and 30 amperes for 10 AWG copper; or 15 amperes for 12 AWG and 25 amperes for 10 AWG aluminum and copper-clad aluminum.

TABLE 4.
STANDARD KW INPUTS

Standard KW Ratings	Immersion Heaters***	Number of 50A Contractors			Full Load Current In Amperes						
					Single Phase				Three Phase		
		No. Of Wattage	208V	240V	480V	208V	240V	277V	480V	208V	240V
3	1 3,000				14.4	12.5	10.8	6.3	8.3	7.2	3.6
6	1 6,000	1			28.8	25.0	21.2	12.5	16.7	14.4	7.2
9	1 9,000		1		43.3	37.5	32.5	18.8	25.0	21.7	10.8
12	1 12,000			1	57.7	50.0	43.3	25.0	33.3	28.9	14.4
15	1 15,000				72.1	62.5	54.2	31.3	41.6	36.1	18.0
18*	1 18,000				86.5	75.0	65.0	37.5	50.0	43.3	21.7
24	2 12,000	2			115.4	100.0	86.6	50.0	66.6	57.7	28.9
30	2 15,000		2		144.2	125.0	108.3	62.5	83.3	72.2	36.1
					173.1	150.0	130.0	75.0	99.9	86.6	43.3
36*	2 18,000				216.3	187.5	162.5	93.8	124.9	108.3	54.1
45	3 15,000	3	3		N/A	225.0	194.9	112.5	149.9	129.9	65.0
54	3 18,000			2	N/A	250.0	216.6	125	166.7	145	72
60**	4 15,000	4	4		N/A	N/A	N/A	156	208.4	181	90
75**	5 18,000	5	5	3	N/A	N/A	N/A	188	250	217	108
90**	5 18,000				N/A	N/A	N/A				

* 208V models use one additional immersion heater.
 ** Available on 50 gallon models or larger.
 *** Each immersion heater contains three electric elements.

WIRING DIAGRAMS

DIAGRAM 1.
SMALL COMMERCIAL WIRE DIAGRAM
208-240V / 3PH

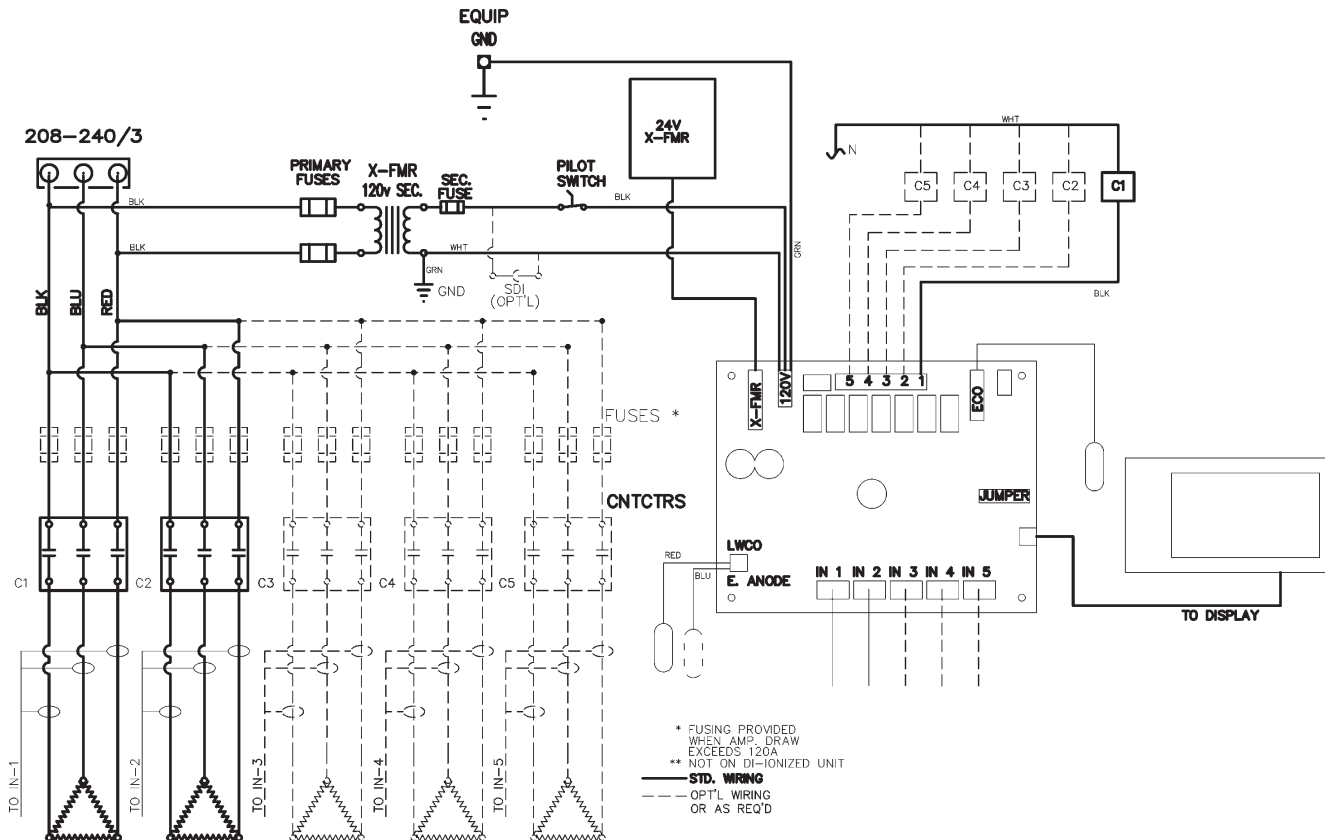
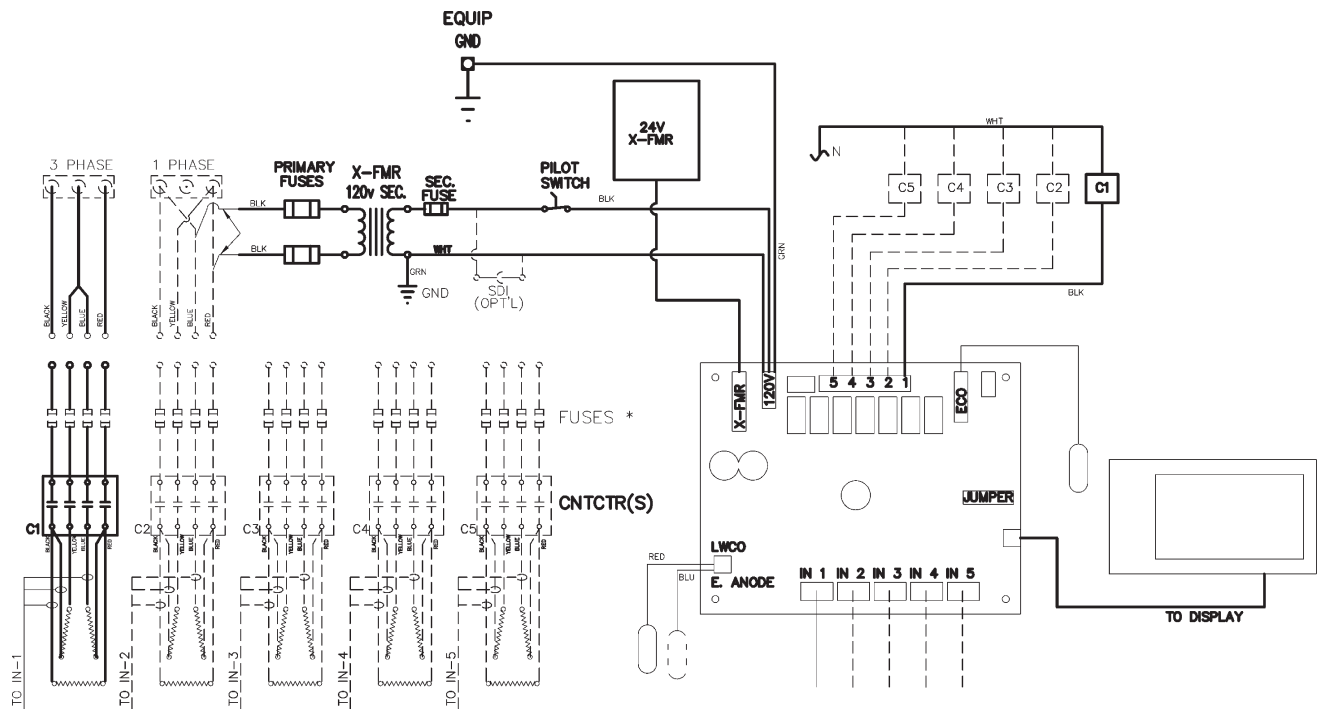

DIAGRAM 2.
SMALL COMMERCIAL WIRE DIAGRAM
208-240V / 3-1PH



3-1 PHASE CONVERSIONS

In the case where the unit is phase convertible and it has only one contactor, jumper wires (provided) must be added according to the phase of the supply voltage. See the diagram below. For single-phase connection, jumpers A-C and B-D must be added. For three-phase connection, jumper B-C must be added.

3-1 PHASE CONTACTOR JUMPER CONFIGURATION

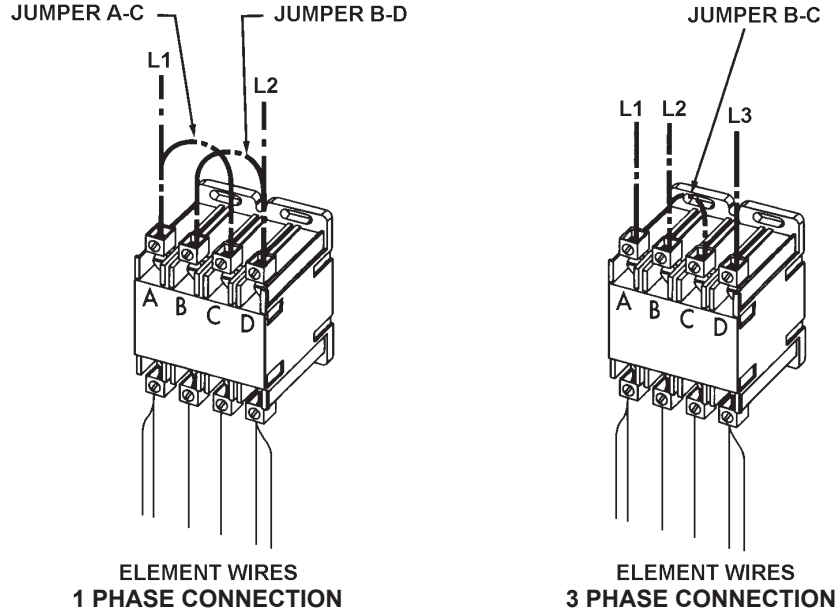

DIAGRAM 3.
SMALL COMMERCIAL WIRE DIAGRAM
SINGLE PHASE

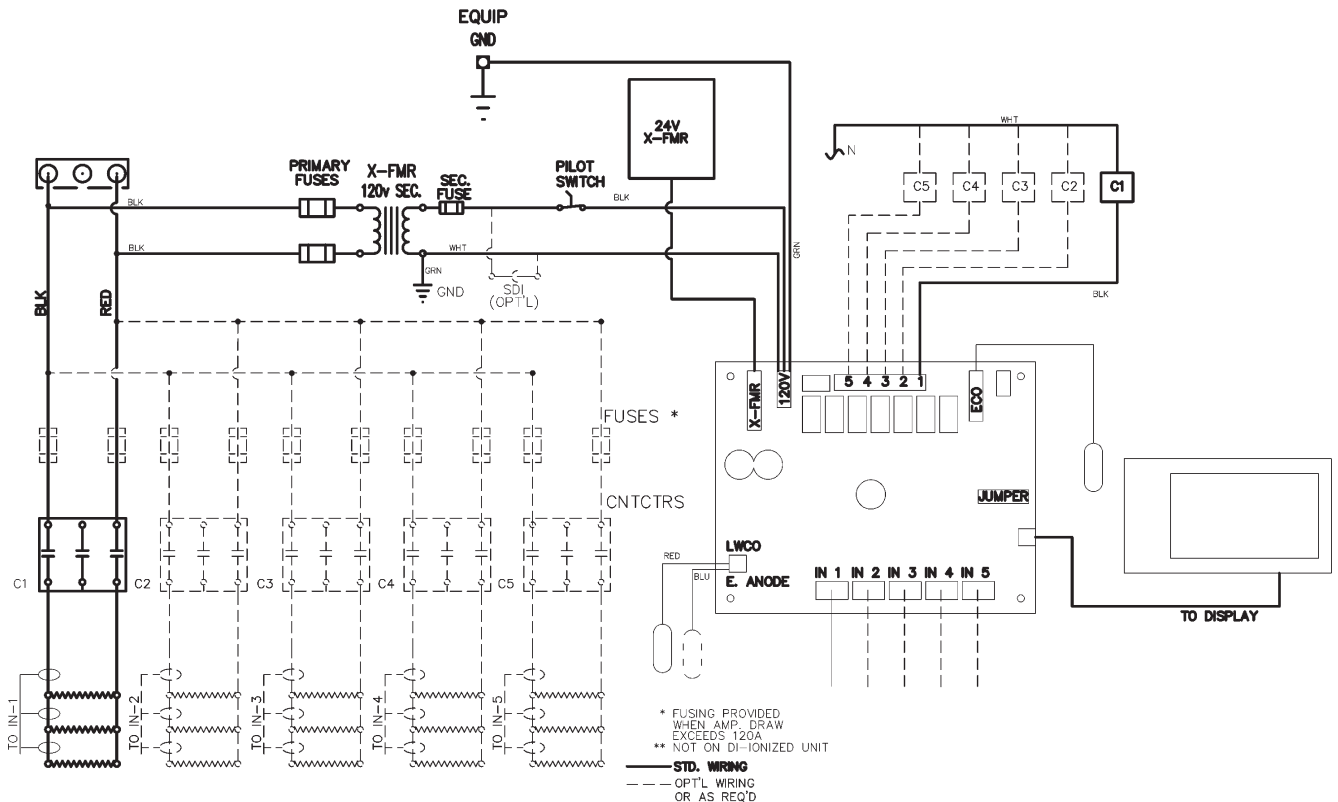

DIAGRAM 4.
SMALL COMMERCIAL WIRE DIAGRAM
300-600V / 3PH

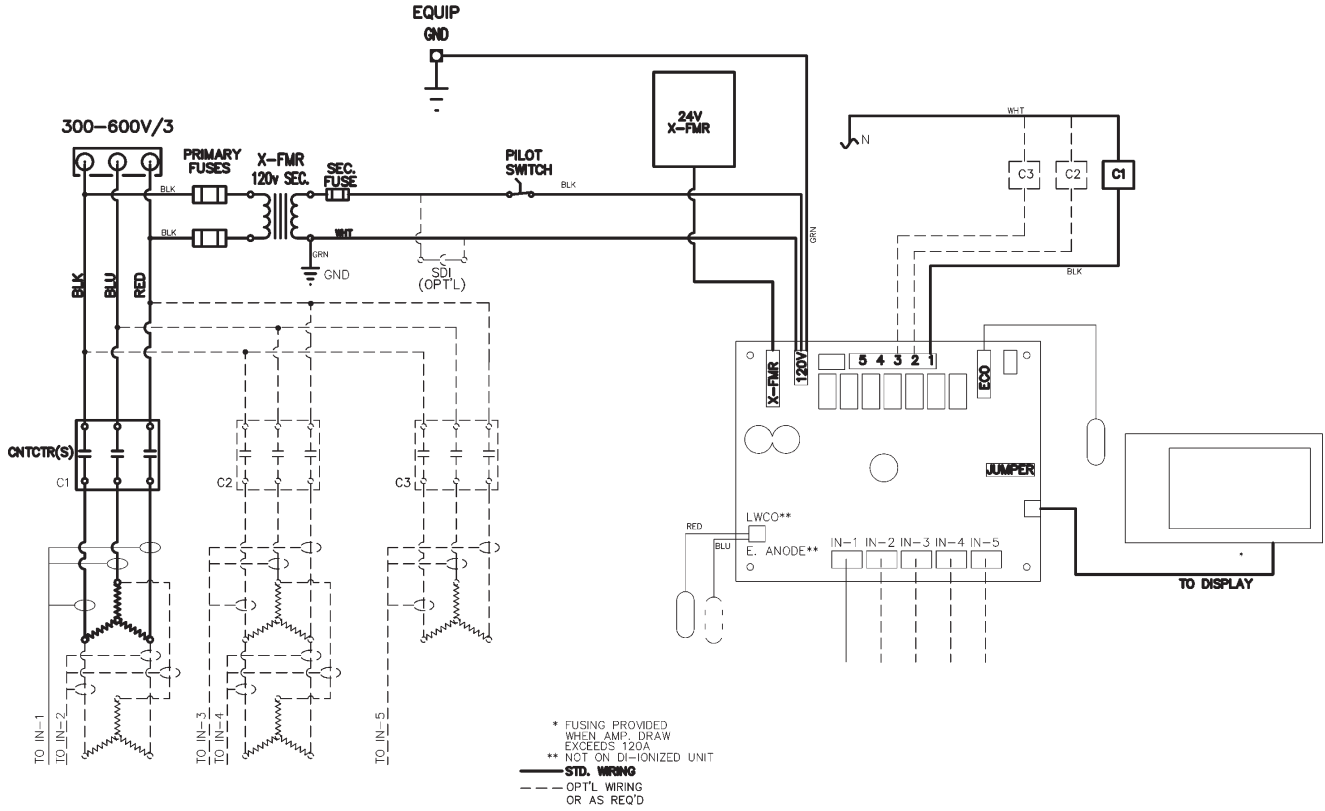
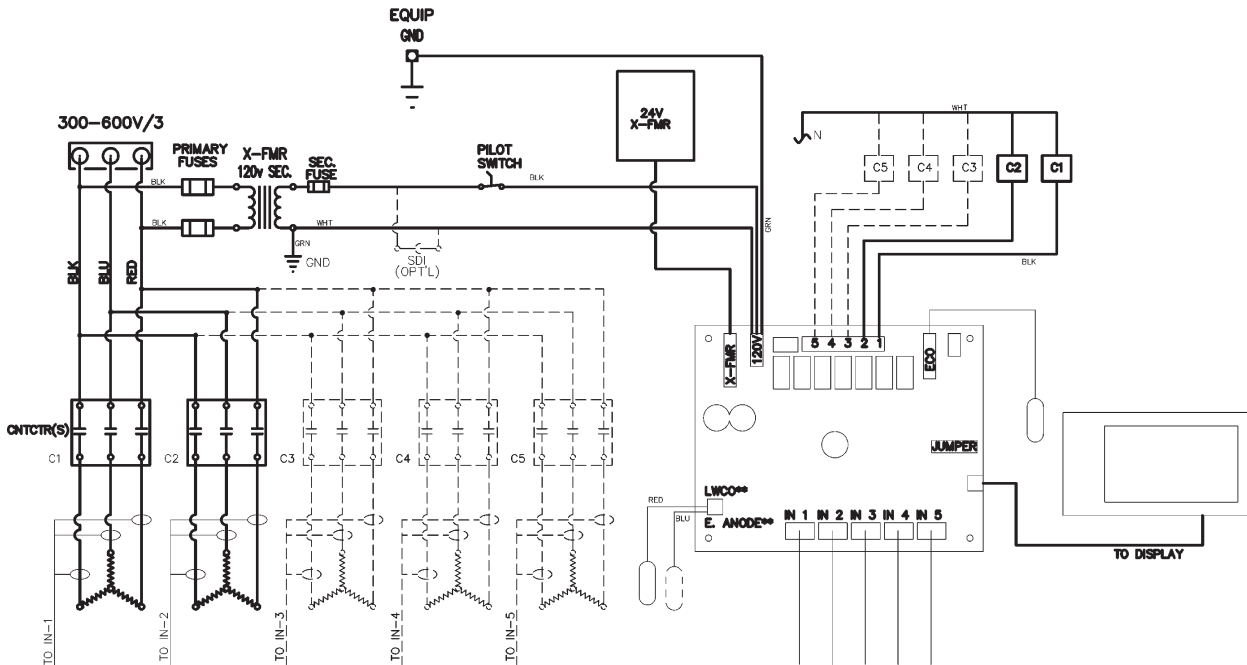

DIAGRAM 5.
SMALL COMMERCIAL ELECTRIC
300-600V 3ph, Linear or Progressive



OPERATION

GENERAL

Refer to the Features and Components section of this manual for the location of components mentioned in the instructions that follow.

NEVER operate the heating elements without being certain the water heater is filled with water, and a temperature and pressure relief valve is installed in the relief valve opening on top of the heater.

Some models will be equipped with an optional LWCO (low water cut off). The water probe is installed in the storage tank – see the Features and Components illustrations at the beginning of this manual for location. The control system will declare a Fault condition and lock out (de-energize contactor coils and heating elements) if the water level is below this point.

The pilot switch (power on/off toggle switch) on the cabinet front permits the heater to be turned on and off without having to operate the electrical disconnect switch.

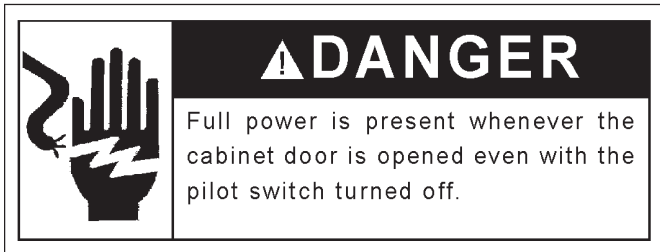

Optional manual override switches on the cabinet front allow elements to be manually de-energized if full capacity is not needed.

FILLING THE WATER HEATER



To fill the water heater with water:

1. Turn off the electrical disconnect switch.
2. Turn off pilot toggle switch.
3. Close the heater drain valve.
4. Open a nearby hot water faucet to allow the air in the system to escape.
5. Fully open the cold water inlet valve, filling the heater and piping.
6. Close the hot water faucet when water starts to flow from the faucet. Leave the cold water inlet valve fully open. The heater is now ready for start up and temperature regulation.

7. Close the cabinet door and perform start up checks listed below before turning on the electricity.

INITIAL START UP

The following checks should be made by the installer when the water heater is placed into operation for the first time:

1. Check all factory and field made water and electrical connections for tightness. Also check connections on top of the heater. Repair water leaks and tighten electrical connections as necessary.
2. Turn on the electrical disconnect switch and pilot toggle switch. The pilot toggle switch is located on cabinet.
3. Observe the operation of the electrical components during the first heating cycle. **Use care as the electrical circuits are energized.**

Temperature control and contactor operation should be checked by allowing heater to come up to temperature and shut off automatically. **USE CARE AS THE ELECTRICAL CIRCUITS ARE ENERGIZED.**

DRAINING THE WATER HEATER

The water heater must be drained if it is to be shut down and/or exposed to freezing temperatures. Maintenance and service procedures may also require draining the heater.

1. Turn off the electrical disconnect switch.
2. Turn off pilot toggle switch.
3. Open a nearby hot water faucet until the water is no longer hot.
4. Close the cold water inlet valve to heater.
5. Open drain valve.
6. If the heater is being drained for an extended shutdown, it is suggested the drain valve be left open during this period.

Follow FILLING instructions when restoring hot water service, see the list above.

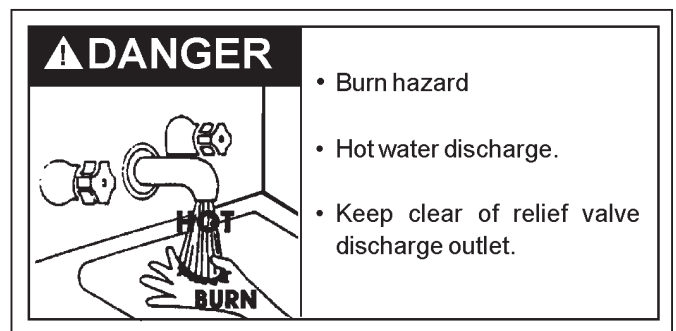

TEMPERATURE REGULATION

HIGH TEMPERATURE LIMIT CONTROLS (ECO)

This water heater is equipped with an ECO (energy cut out) non adjustable high temperature limit control. An ECO is a normally closed switch that opens (activates) on a rise in temperature. If the ECO switch contacts open (activate) due to abnormally high water temperatures the control system will lock-out and disable further heating element operation. It is important that a qualified service agent be contacted to determine the reason for the ECO activation before resetting the ECO. Once the reason has been determined and corrected the ECO can be reset as follows:

The ECO high temperature limit switch is located inside the immersion temperature probe (two red wires). The ECO switch contacts will open when the water temperature reaches approximately 202°F/94°C and close at approximately 120°F/49°C. When the ECO switch contacts open (activate) the electronic control system locks out and displays a Fault message. Voltage to the contactor coils and heating elements is terminated to prevent further heating operation. Should the ECO activate, the water temperature must drop below 120°F/49°C before the control system can be reset. Once the water temperature has cooled below this point the power supply to the water heater must be turned off and on again to reset the control system.

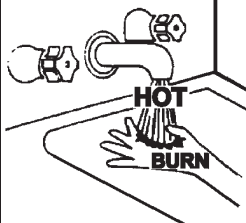

⚠ DANGER Water temperature over 125°F (52°C) can cause severe burns instantly resulting in severe injury or death.

Children, the elderly, and the physically or mentally disabled are at highest risk for scald injury.

Feel water before bathing or showering.

Temperature limiting valves are available.

Read instruction manual for safe temperature setting.

THERMOSTAT CONTROLS

The water heaters covered in this instruction manual are equipped with adjustable thermostat controls to control water temperature. Hot water temperatures required for automatic dishwasher and laundry use can cause scald burns resulting in serious personal injury and/or death. The temperature at which injury occurs varies with the person's age and duration of exposure. The slower response time of children, the elderly or disabled persons increases the hazards to them. Never allow small children to use a hot water tap or draw their own bath water. Never leave a child or disabled person unattended in a bathtub or shower. The water heater should be located in an area where the general public does not have access to set temperatures.

Setting the water heater temperatures at 120°F will reduce the risk of scalds. Some States require settings at specific lower temperatures.

Figure 3. shows the approximate time-to-burn relationship for normal adult skin.

TEMPERATURE ADJUSTMENT



⚠ DANGER

Full power is present whenever the cabinet door is opened even with the pilot switch turned off.

The water heaters covered in this instruction manual are equipped with an electronic control system. The control system senses temperature from a factory installed immersion temperature probe – see the Features and Components illustrations at the beginning of this manual for location. The “Operating Set Point” is adjusted to control water temperature. This is an adjustable user setting in the control system’s “Temperatures Menu.” This and all control system menus are accessed through the UIM (User Interface Module - see Figure 3.) located on the front panel of the water heater.

The Operating Set Point is adjustable from 90°F/42°C to 190°F/88°C. The factory setting is 120°F/49°C. See the Control System Operation section of this manual for instructions on how to adjust the Operating Set Point and other user settings.



Set the Operating Set Point at the lowest setting which produces an acceptable hot water supply. This will always give the most energy efficient operation.

MODEL INFORMATION

Tank Temperature 114°F



Operating Set Point 120°F

Status: Heating

Friday
5:00 PM
Normal Mode

MENU
HELP

Water Temperature °F (°C)	Time for 1st Degree Burn (Less Severe Burns)	Time for Permanent Burns 2nd & 3rd Degree (Most Severe Burns)
110 (43)	(normal shower temp.)	
116 (47)	(pain threshold)	
116 (47)	35 minutes	45 minutes
122 (50)	1 minute	5 minutes
131 (55)	5 seconds	25 seconds
140 (60)	2 seconds	5 seconds
149 (65)	1 second	2 seconds
154 (68)	instantaneous	1 second

(U.S. Government Memorandum, C.P.S.C., Peter L. Armstrong, Sept. 15, 1978)

FIGURE 3.

HEATING ELEMENT OPERATION

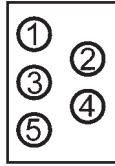

FIGURE 4.

Depending on tank size and how they were ordered from the factory the water heaters covered in this manual may be equipped with 1 to 5 electric heating elements. The illustration here shows how the heating elements are numbered for control purposes and how the openings for each heating element are physically located on the water heater's storage tank.

Control Options

The water heaters covered in this manual are factory ordered with 1 of 3 different heating element control options as follows:

On/Off Control: This is the only configuration available on models equipped with a single heating element and the standard configuration on models equipped with more than one element. All elements are cycled on simultaneously with each call for heat, however there is a one second delay between elements being energized to reduce starting current. All elements are cycled off at the same time at the end of each heating cycle.

Linear Sequencing: Only available on models equipped with multiple heating elements. Elements are energized and de-energized according to adjustable (1 to 20°F) Differential set points for each element. Element Rotation - first element on is rotated with each successive call for heat. First On/Last Off - the first heating element energized at the beginning of a heating cycle is the last element de-energized at the end of the heating cycle. Successive heating cycles would progress as follows on a model equipped with 3 heating elements:

- First heating cycle: Elements come on [1, 2, 3] and cycle off [3, 2, 1].
- Second heating cycle: Elements come on [2, 3, 1] and cycle off [1, 3, 2].
- Third heating cycle: Elements come on: [3, 1, 2] and cycle off [2, 1, 3].
- Fourth heating cycle: pattern repeats - same as first.

Progressive Sequencing: Only available on models equipped with multiple heating elements. Elements are energized and de-energized according to adjustable (1 to 20°F) Differential set points for each element. Element Rotation - first element on is rotated with each successive call for heat. First On/First Off - the first heating element energized at the beginning of a heating cycle is the first element de-energized at the end of the heating cycle. Successive heating cycles would progress as follows on a model equipped with 3 heating elements:

- First heating cycle: Elements come on [1, 2, 3] and cycle off [1, 2, 3].
- Second heating cycle: Elements come on [2, 3, 1] and cycle off [2, 3, 1].
- Third heating cycle: Elements come on: [3, 1, 2] and cycle off [3, 1, 2].
- Fourth heating cycle: pattern repeats - same as first.

CONTROL SYSTEM FEATURES

Advanced Diagnostics

Plain English text and animated icons display detailed operational and diagnostic information. LCD screen on the front of the water heater displays the Sequence of Operation in real time. Fault or Alert messages are displayed when operational problems occur. Advanced Service menu displays a list of possible causes for current Fault and Alert conditions to aid in servicing.

Economy Mode Operation

Control system automatically lowers the Operating Set Point by a programmed value during user defined time periods. Helps reduce operating costs during unoccupied or peak demand periods.

CONTROL SYSTEM NAVIGATION

The UIM (User Interface Module) is located on the front cabinet of the water heater. All operational information and user settings are displayed and accessed using the UIM. The UIM includes five snap acting (momentary) user input buttons; an Up, Down and 3 Operational Buttons.

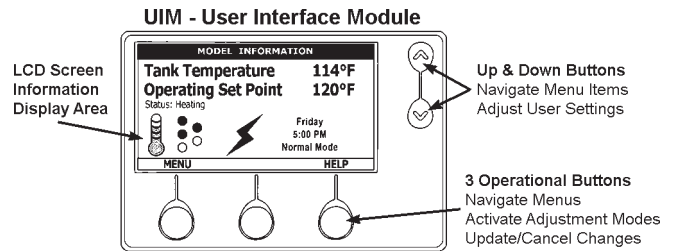

FIGURE 5.

Up & Down Buttons

Used to navigate (up and down) and to select (highlight) menu items. Also used to adjust or change (increase/decrease, on/off, set time) various user settings.

Operational Buttons

The 3 Operational Buttons are multifunctional. Their current function is defined by the text that appears directly above each button on the LCD screen. The function will change depending on what menu is currently displayed or what menu item is selected. When no text appears on the LCD screen above an Operational Button there is no function assigned.

THE DESKTOP SCREEN

The illustration below shows the control system "Desktop Screen." This is the default screen. If there are no active Fault or Alert conditions and no user input for approximately 10 minutes the control system will return to this screen automatically.

Model Information: Model information and menu titles are shown in the black bar at the top of the Desktop Screen.

Tank Temperature: Current water temperature as sensed from the immersion Temperature Probe.

Operating Set Point: Temperature at which the control system will maintain tank (water) temperature in the Normal Mode. This line of text will read Economy Set Point whenever the control system is operating in the Economy Mode.

Status: The Operating State of the control system is displayed beneath the Operating Set Point.

Help: The right Operational Button is pressed to access instructions and explanations for user settings, Operating States, Status Icons, manufacturer’s web address, technical support phone number and service agent contact information.

Service Note: The Desktop Screen displays text and animated icons that convey operational information.

Review the Status Icons explanation in Table 3. Learning to use this real time visual display of the operating sequence will help to quickly and accurately diagnose operational problems.

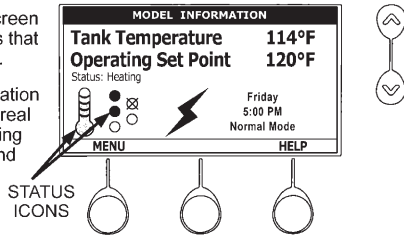

FIGURE 6.

Day/Time/Operating Mode: The current time and day are also displayed on the Desktop Screen. “Clock Not Set” will be displayed until the time clock has been initially set. Day and Time are adjusted in the Economy Mode Setup menu. The current Operating Mode, either Normal Mode or Economy Mode, is displayed beneath the day and time.

Discreet Menu Contact Information: From the Desktop Screen press and hold down the middle (unmarked) Operational Button for 30 seconds and then release it. This will launch a discreet menu where personalized contact information can be entered. Installing contractors and/or service agents can enter their company name and telephone number. This contact information will be displayed with all Fault and Alert messages.

Menu: The left Operational Button is pressed to enter the Main Menu where all control system menus are accessed. See Table 7. for a list of control system menus.

TABLE 5. - STATUS ICONS

ICON	DESCRIPTION
	Water temperature in the tank has fallen. Shaded area of the animated thermometer icon will rise and fall in response to water temperature in the storage tank as sensed from the immersion Temperature Probe.
	Water temperature in the tank has reached the Operating Set Point. Shaded area of the animated thermometer icon will rise and fall in response to water temperature in the storage tank as sensed from the immersion Temperature Probe.
	The control is unable to initiate a heating cycle. This will happen whenever a Fault condition is detected by the control system or when either of the two Enable/Disable circuits are open circuits.
	The control system is in Heating Mode and has energized the electromagnetic contactor coils for at least one heating element. This animated icon DOES NOT indicate current has been sensed from the heating elements, only that there is a call for heat present and the control system has initiated heating element operation.
	Heating element icon for a water heater equipped with 1 heating element. Open circles represent elements the control system has not energized and IS NOT sensing electrical current flow from.
	Heating element icon for a water heater equipped with 2 heating elements. Each circle represents one element. Open circles represent elements the control system has not energized and IS NOT sensing electrical current flow from. Filled circles represent elements the control system has energized and IS sensing electrical current flow from.
	Heating element icon for a water heater equipped with 3 heating elements. Each circle represents one element. Filled circles represent elements the control system has energized and IS sensing electrical current flow from.
	Heating element icon for a water heater equipped with 4 heating elements. Each circle represents one element. Open circles with an X represent elements the control system has energized that it IS NOT sensing electrical current flow from.
	Heating element icon for a water heater equipped with 5 heating elements. Each circle represents one element. Open circles represent elements the control system has not energized and IS NOT sensing electrical current flow from. Filled circles represent elements the control system has energized and IS sensing electrical current flow from.
	The control has detected/declared a Fault Condition. Fault message details can be viewed in the Current Fault menu. Heating operation is discontinued (locked out) until the condition that caused the fault is corrected. Power to the water heater must be cycled off and on to reset the control system. Note; cycling power will not reset the control system if the condition that caused the fault has not been corrected.
	The control has detected/declared an Alert Condition. The water heater will continue to operate during an Alert Condition but there is an operational condition that requires the attention of a Qualified Service Agent. Alert message details can be viewed in the Current Alert menu.

TABLE 6. - OPERATING STATES

STATE	DESCRIPTION
Standby	The water heater is not in an active heating cycle. This usually indicates the temperature in the tank has reached the Operating Set Point and the control system has terminated the heating cycle.
Heating	The control system is in the Heating Mode. At least one heating element has been energized.
Alert	The control system has detected/declared an Alert Condition. The controls system will continue heating operation. However, a Qualified Service Agent should be contacted to check/service the water heater.
Fault	The control system has detected/declared a Fault Condition. The control system will discontinue heating operation and "lock out." Power to the water heater must be cycled off and on to reset the control system. Note; cycling power will not reset the control system until the condition that caused the fault has been corrected.

TABLE 7. - CONTROL SYSTEM MENUS

MENUS	DESCRIPTION
Temperatures	Most commonly accessed menu. Operating Set Point, Differential settings, Tank Temperature and Tank Probe Offset are located in this menu.
Heater Status	Current Operating State/Mode (heating/standby etc) and status (open/closed - on/off - yes/no) of monitored water heater functions and components are displayed in this menu.
Economy Mode Setup	Seven day 24 hour time clock with temperature set back capability to reduce operating costs during unoccupied or reduced demand periods.
Alarm Output Setup	The control system's CCB (Central Control Board - see wiring diagrams) features on board SPDT (single pole double throw) relay contacts for building EMS (Energy Management System) notification of operational conditions such as Fault Conditions and heating mode status. This menu features a list of user definable conditions for relay activation.
Display Settings	Temperature units (°F or °C), appearance (brightness contrast) and backlight delay user adjustable settings are located in this menu.
Heater Information	Elapsed time of operation, total heating cycle time, heating cycle count, heating element(s) cycle count and on time along with UIM and CCB software revisions can be viewed in this menu.
Current Fault/Alert	Displays any current Alert or Fault messages.
Fault History	Retains 9 event history of Fault/Alert messages with time stamp. The Fault History is useful when dealing with intermittent operational problems or when the customer has reset the control system prior to a service agent's arrival.
Fault Occurrence	Total accumulated number each individual Fault condition has occurred is displayed in this menu. This running total of Fault Occurrences can be useful in determining which (if any) operational problems have been persistent.
Restore Factory Defaults	This control system feature allows the user to restore control system user settings to their factory default settings. Alarm Output Setup and Display Settings menu items ARE NOT changed when factory defaults are restored.
Help Menu	Accessible by pressing the corresponding Operational Button from most menus and screen displays. This menu provides access to instructions and explanations for user settings, Operating States, Status Icons, manufacturer's web address, technical support phone number and service agent contact information.

TEMPERATURES MENU

Operating Set Point

User adjustable setting 90°F to 190°F range; factory default is 120°F. When the water temperature sensed by the control system from the immersion Temperature Probe reaches the Operating Set Point the control system will end the heating cycle. A call for heat will be activated again when the water temperature drops below the Operating Set Point minus the 1st Differential Setting.

Example: Operating Set Point is 120°F, the 1st Differential Setting is 2°F (factory default). A call for heat will be activated when the sensed water temperature drops to 118°F.

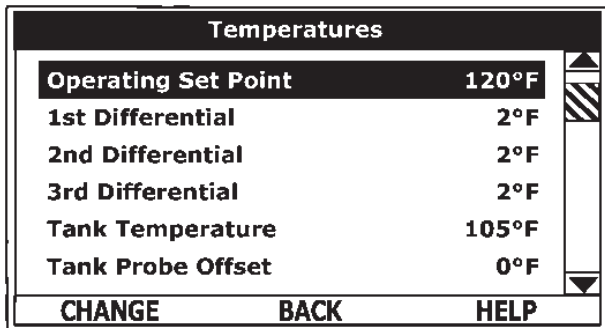

Temperatures	
Operating Set Point	120°F
1st Differential	2°F
2nd Differential	2°F
3rd Differential	2°F
Tank Temperature	105°F
Tank Probe Offset	0°F
CHANGE	BACK HELP

Differential Settings

Adjustable user setting(s) 1°F to 20° range; factory default is 2°F. The water heaters covered in this manual will have between 1 and 5 heating elements. There is at least one Differential Setting on all models. There will be additional Differential Settings for each additional heating element installed.

Operating Sequence

On a water heater equipped with 3 heating elements, with an Operating Set Point of 120°F and all Differential settings at 2°F the On/Off sequencing of heating elements would be as follows:

TABLE 8.

ELEMENT NUMBER	DIFFERENTIAL SETTING	TURN ON TEMP	TURN OFF TEMP
Element 1	2°F	118°F	120°F
Element 2	2°F	116°F	118°F
Element 3	2°F	114°F	116°F

Tank Temperature

Non adjustable information display. Current water temperature as sensed by the control system from the immersion Temperature Probe.

Tank Probe Offset

User adjustable setting -5°F to +5°F range; factory default is 0°F. If the current Tank Temperature is sensed (from the immersion Temperature Probe) at 120°F and the offset is adjusted to -5°F the control system would calibrate or "offset" the Tank Temperature to 115°F. Heating cycles would then start/stop based on the calibrated Tank Temperature.

Used to calibrate for slight differences in control system temperature sensing. This can improve the precision of temperature control in the storage tank and at points of use. This feature can also be used to compensate for building recirculation loops (hot water returning to the storage tank) that may cause the heating cycle to terminate prematurely.

Temperature Settings

The Operating Set Point and the Differential Settings are adjusted in the Temperatures Menu. The following instructions explain how to adjust these user settings and navigate the control system menus.

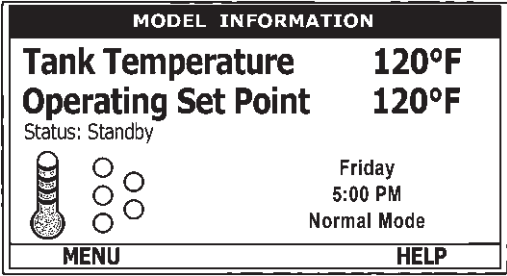
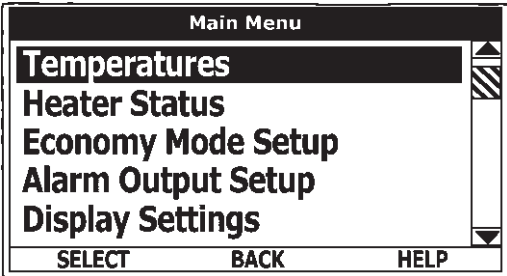
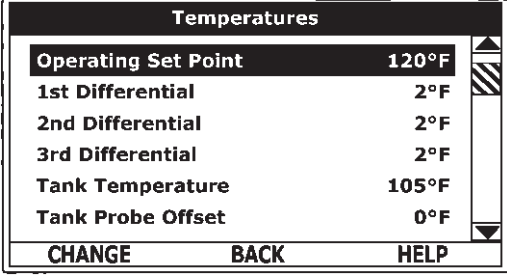
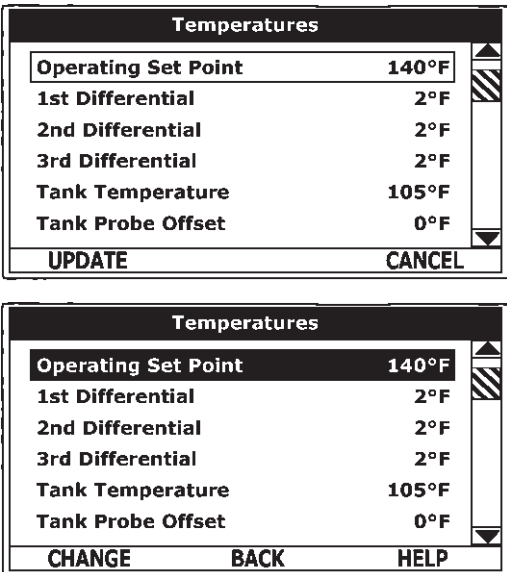
ACTION	DISPLAY
<p>From the Desktop Screen, press the Operational Button underneath "MENU" to enter the Main Menu.</p> <p>Notice how the text above the Operational Buttons on the display changes as you navigate through the various menus and screens.</p>	
<p>With Temperatures selected (highlight in black) in the Main Menu, press the Operational Button underneath "SELECT" to enter the Temperature Menu.</p> <p>If Temperatures is not selected use the Up and Down buttons to select this menu item.</p>	
<p>With the Operating Set Point selected (highlighted in black) in the Temperatures Menu, press the Operational Button underneath "CHANGE" to activate the adjustment mode for this menu item.</p>	
<p>Press the Up and Down buttons to adjust the Operating Set Point to the desired setting.</p> <p>Press the Operational Button underneath "UPDATE" to confirm the new setting. Press the Operational Button underneath "CANCEL" to discard the new setting and retain the previous setting.</p> <p>The new Operating Set Point value should now be displayed as the current value.</p> <p>NOTE: Use this same procedure to adjust the Differential settings and the Tank Probe Offset in the Temperatures Menu.</p> <p>This same procedure is used to change user settings in other control system menus.</p>	

HEATER STATUS MENU

This menu displays non adjustable operational information. Use the Up & Down Buttons to navigate to the bottom of this menu.

Top of Menu

Heater Status	
Status	Heating
Elements On	1
ECO Contact	Closed
Enable / Disable 1	Closed
Enable / Disable 2	Closed
Element 1 On	Yes
Element 2 On	No
BACK HELP	

Bottom of Menu

Heater Status	
Enable / Disable 2	Closed
Element 1 On	Yes
Element 2 On	No
Element 3 On	No
Tank Full	Yes
Alarm Condition	No
Alarm Relay Output	Open
BACK HELP	

Status

Displays the current Operating State of the control system. IE: Heating, Standby, Fault.

Elements On

Displays the number of heating elements the control system has energized.

ECO Contact

Displays the current state of the ECO high temperature limit switch contacts.

Enable / Disable 1 & 2

Displays the current state, open or closed, of the two Enable/Disable circuits (J7 socket on the CCB - see wiring diagrams) provided for external supervisory controls such as building EMS (Energy Management System). Both of these Enable/Disable circuits must be closed to "enable" heating operation. If either Enable/Disable circuit is open for any reason heating operation will be "disabled." There is a plug with two jumper wires installed from the factory in the CCB J7 socket to enable heating operation when external controls are not in use.

Service Note: If a supervisory control(s) is used to enable/disable heating operation, install field wiring between the J7 socket on the CCB and a set of "dry contacts" on the external control per all applicable building codes. This is a switching circuit only: DO NOT apply any external voltage or connect any load (IE: relay coil) to either circuit.

Element # On

Displays the on/off status of each heating element. Yes = On, No = Off.

Tank Full

Displays the status of the optional LWCO (Low Water Cut Off) device. Yes = water level is acceptable, No = water level is low.

Alarm Condition

Displays the status of the user definable Alarm Output function - see Alarm Output Setup Menu. Yes = alarm condition has been met, No = alarm condition has not been met.



Alarm Relay Output

Displays the state of the normally open contacts of the Alarm Output relay. This relay (J3 contacts on the CCB - see wiring diagrams) is used for building EMS (Energy Management System) notification of operational conditions such as Fault conditions.

ECONOMY MODE SETUP MENU

This menu contains settings used to establish an "Economy Set Point" and "Economy Mode" operating periods. This control system feature can help reduce operating costs during unoccupied, low load, or peak demand periods.

Desktop Screen During Economy Mode

MODEL INFORMATION	
Tank Temperature	120°F
Economy Set Point	100°F
Status: Standby	
	Friday
	5:00 PM
	Economy Mode
MENU HELP	

Economy Mode Setup Menu

Economy Mode Setup	
Setpoint Adjustment	20
Current Time	Mon 5:00 PM
Heater In Economy Mode	No
Sun	Economy Mode All Day
Mon	Normal 7:30 AM to 8:00 PM
Tue	Normal All Day
Wed	Normal All Day
CHANGE BACK HELP	

Setpoint Adjustment

Adjustable user setting (2°F to 50°F - factory default is 20°F) the control system uses to calculate the "Economy Set Point." The Economy Set Point = normal Operating Set Point minus the programmed Setpoint Adjustment value.

The Economy Set Point is the water temperature the control system maintains during programmed Economy Mode time periods. "Economy Set Point" is displayed instead of "Operating Set Point" and "Economy Mode" appears beneath the current time on the Desktop Screen during Economy Mode time periods.

Current Time

Seven Day 24 hr clock. Use this menu item to set the current time and day of the week. Current day and time are not set from the factory. "Clock Not Set" will be displayed on the Desktop until the time/day has been initially set. Note: the time will not self adjust for Daylight Savings time.

Heater In Economy Mode

Displays whether the control system is currently operating in Economy Mode or not.

Daily Operating Mode (Sun - Mon - Tue - Wed - Thu - Fri - Sat)

Seven daily sub menus are listed at the bottom of the Economy Mode Setup menu. There are 3 Operating Modes in each sub menu; "Normal Operation All Day" - "Economy Mode All Day" and "Normal Operation Between." Only one Operating Mode can be active, the factory default is Normal Operation All Day.

Normal Operation All Day: When this operating mode is active the normal Operating Set Point is used for the entire day.

Economy Mode All Day: When this operating mode is active the Economy Set Point is used for the entire day.

Normal Operation Between: When this operating mode is active there will also be start and stop times to program. The normal Operating Set Point is used between the programmed start and stop times and the Economy Set Point will be in effect during the rest of the day. There is one start time and one stop time event per day.

ECONOMY MODE SETTINGS

Setpoint Adjustment Value

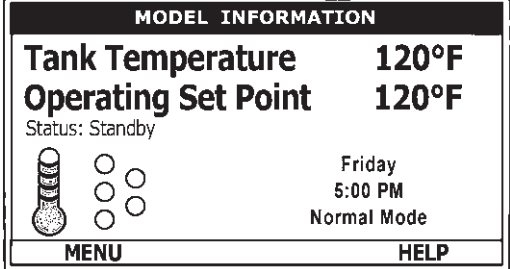
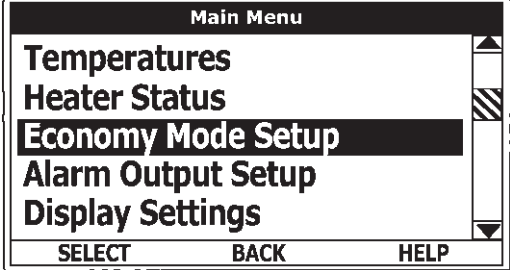
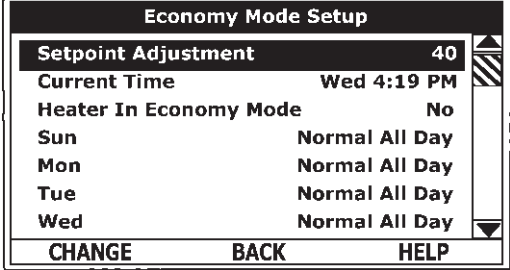
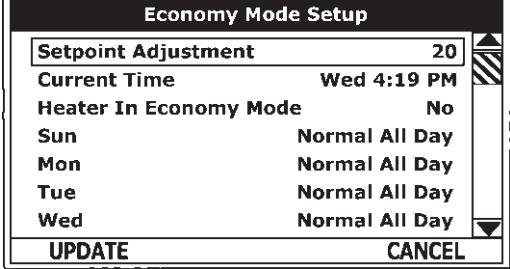
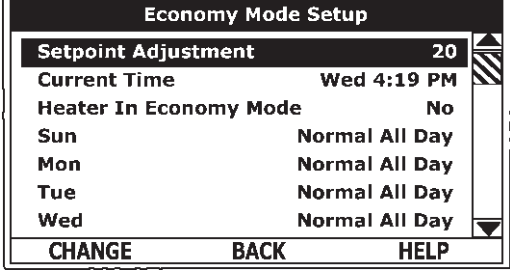
ACTION	DISPLAY
<p>From the Desktop screen, press the Operational Button underneath "MENU" to enter the Main Menu.</p> <p>Notice how the text above the Operational Buttons on the display changes as you navigate through the various menus and screens.</p>	
<p>Use the Up/Down buttons to select (highlight in black) the Economy Mode Setup menu from the Main Menu. Press the Operational Button underneath "SELECT" to enter the Economy Mode Setup menu.</p>	
<p>Use the Up/Down buttons to select (highlight in black) Setpoint Adjustment. Press the Operational Button underneath "CHANGE" to activate the adjustment mode for the Setpoint Adjustment value.</p>	
<p>Use the Up/Down buttons to change the Setpoint Adjustment to the desired value. The Setpoint Adjustment value is adjustable from 2°F to 50°F. The factory default is 20°F.</p> <p>Notice how the text above the Operational Buttons on the display changes to "UPDATE" & "CANCEL" when the adjustment mode is activated and how the current value is outlined rather than highlighted in black.</p> <p>Press the Operational Button underneath "UPDATE" to enter and confirm the new value. Pressing the Operational Button underneath "CANCEL" would discard the new value and retain the previous value.</p>	
<p>The new Setpoint Adjustment value should now be displayed as the current value.</p>	

ECONOMY MODE SETTINGS

Time Clock Settings

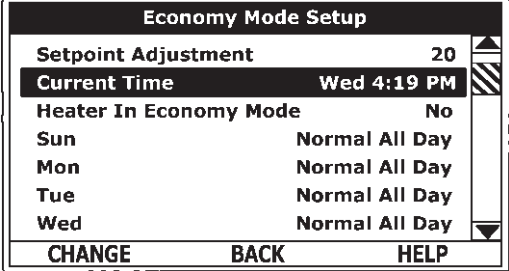
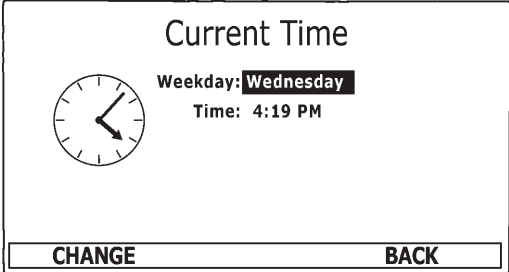
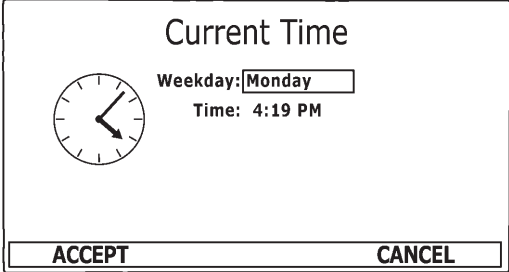
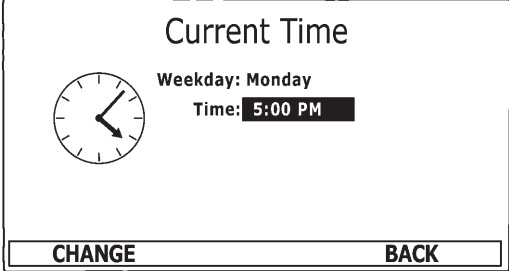
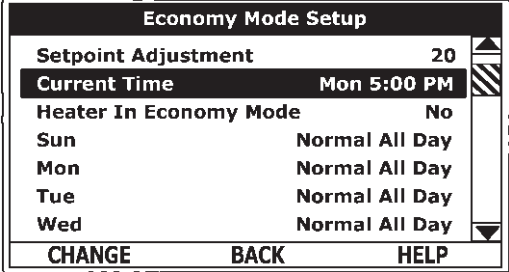
ACTION	DISPLAY
<p>From the Desktop Screen navigate to the Economy Mode Setup menu.</p> <p>Use the Up/Down buttons to select (highlight in black) Current Time sub menu. Press the Operational Button underneath "CHANGE" to enter the Current Time sub menu.</p>	
<p>Use the Up/Down buttons to select the "Weekday" setting.</p> <p>Press the Operational Button underneath "CHANGE" to activate the adjustment mode for this setting.</p>	
<p>Press the Up and Down buttons to adjust the Weekday setting to the current day.</p> <p>Notice how the text above the Operational Buttons on the display changes to "ACCEPT" & "CANCEL" when the adjustment mode is activated and how the current setting is outlined rather than highlighted in black.</p> <p>Press the Operational Button underneath "ACCEPT" to enter and confirm the new setting. Pressing the Operational Button underneath "CANCEL" would discard the new setting and retain the previous setting.</p>	
<p>Use the Up/Down and the CHANGE/ACCEPT Operational Buttons to individually select and change the remaining time settings (Hour, Minutes, AM/PM) to the current time in the same way as outlined above.</p> <p>When finished making changes press the Operational Button underneath "BACK" to confirm all new settings and update the control system. The display will automatically return to the Economy Mode Setup menu.</p>	
<p>The new settings should be displayed as the Current Time.</p>	

ECONOMY MODE SETTINGS

Daily Operating Mode Settings

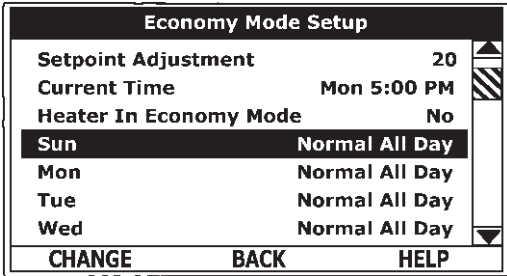
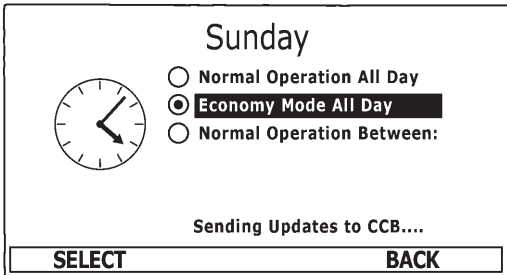
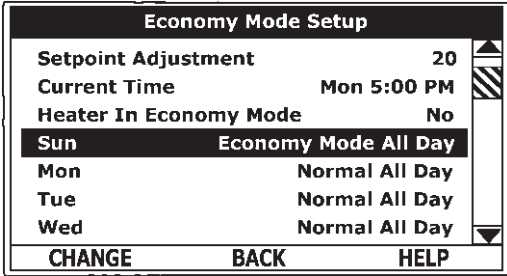
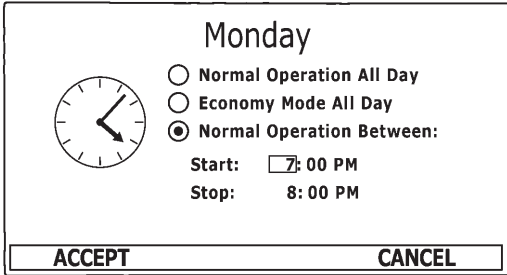
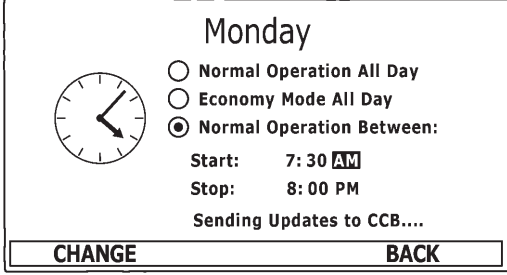
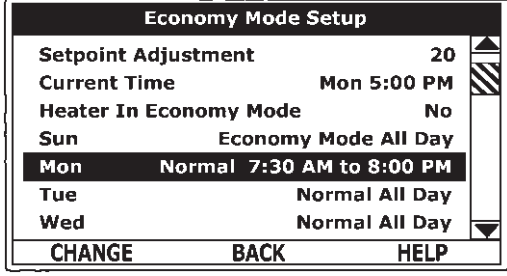
ACTION	DISPLAY
<p><u>Economy Mode All Day:</u></p> <p>From the Economy Mode Setup menu use the Up/Down buttons to select (highlight in black) the Daily sub menu for “Sun.” Press the Operational Button underneath “CHANGE” to enter this menu.</p>	 <p>Economy Mode Setup</p> <p>Setpoint Adjustment 20</p> <p>Current Time Mon 5:00 PM</p> <p>Heater In Economy Mode No</p> <p>Sun Normal All Day</p> <p>Mon Normal All Day</p> <p>Tue Normal All Day</p> <p>Wed Normal All Day</p> <p>CHANGE BACK HELP</p>
<p>Use the Up/Down buttons to select (highlight in black) the “Economy Mode All Day” setting.</p> <p>Press the Operational Button underneath “SELECT” to change from the factory default Normal Operation All Day setting to the Economy Mode All Day setting.</p> <p>Press the Operational Button underneath “BACK” to confirm the new setting and update the control system. You will be returned to the Economy Mode Setup menu. The new setting should now be displayed for Sun.</p>	 <p>Sunday</p> <p><input type="radio"/> Normal Operation All Day</p> <p><input checked="" type="radio"/> Economy Mode All Day</p> <p><input type="radio"/> Normal Operation Between:</p> <p>Sending Updates to CCB....</p> <p>SELECT BACK</p>  <p>Economy Mode Setup</p> <p>Setpoint Adjustment 20</p> <p>Current Time Mon 5:00 PM</p> <p>Heater In Economy Mode No</p> <p>Sun Economy Mode All Day</p> <p>Mon Normal All Day</p> <p>Tue Normal All Day</p> <p>Wed Normal All Day</p> <p>CHANGE BACK HELP</p>
<p><u>Normal Operation Between:</u></p> <p>From the Economy Mode Setup menu Use the Up/Down and CHANGE buttons to enter the Mon sub menu as described above.</p> <p>Use the Up/Down buttons to select (highlight in black) the “Normal Operation Between” setting. Press the Operational Button underneath “SELECT” to change the operating mode for Monday to Normal Operation Between. Note that when this setting is selected Start and Stop time user settings appear on the display.</p> <p>Use the Up/Down buttons to navigate between the Start and Stop time Hour, Minutes and AM/PM settings.</p> <p>With each item selected press the Operational Button underneath “CHANGE” to activate the adjustment mode for each setting. Use the Up/Down buttons to change the value to the desired setting.</p> <p>Press the Operational Button underneath “ACCEPT” to enter the new setting or “CANCEL” to discard the new setting and retain the previous setting.</p> <p>Press the Operational Button underneath “BACK” when finished to confirm the new settings and update the control system. The display will return to the Economy Mode Setup menu with the new settings shown for Mon.</p>	 <p>Monday</p> <p><input type="radio"/> Normal Operation All Day</p> <p><input type="radio"/> Economy Mode All Day</p> <p><input checked="" type="radio"/> Normal Operation Between:</p> <p>Start: 7:00 PM</p> <p>Stop: 8:00 PM</p> <p>ACCEPT CANCEL</p>  <p>Monday</p> <p><input type="radio"/> Normal Operation All Day</p> <p><input type="radio"/> Economy Mode All Day</p> <p><input checked="" type="radio"/> Normal Operation Between:</p> <p>Start: 7:30 AM</p> <p>Stop: 8:00 PM</p> <p>Sending Updates to CCB....</p> <p>CHANGE BACK</p>  <p>Economy Mode Setup</p> <p>Setpoint Adjustment 20</p> <p>Current Time Mon 5:00 PM</p> <p>Heater In Economy Mode No</p> <p>Sun Economy Mode All Day</p> <p>Mon Normal 7:30 AM to 8:00 PM</p> <p>Tue Normal All Day</p> <p>Wed Normal All Day</p> <p>CHANGE BACK HELP</p>

ALARM OUTPUT SETUP MENU

Permits user to set the condition (from a list of options) for when the CCB's integral alarm output relay will be energized. Alarm relay connections (common, normally open, normally closed) are located on the J3 terminal strip on the CCB - see wiring diagrams. Alarm output relay contacts are capable of switching **1 amp maximum at 120 VAC**.

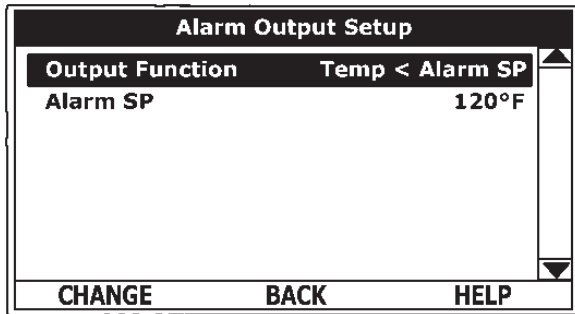
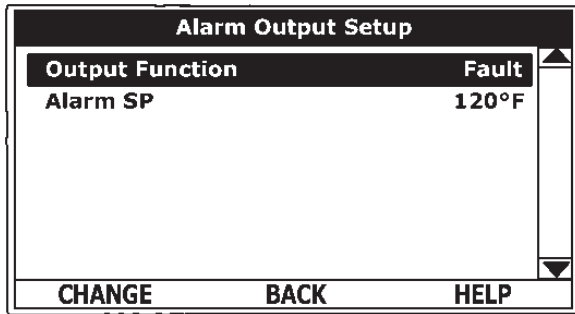

The alarm relay operates in the background according to the settings in this menu and is not capable of disabling water heater operation. The alarm relay is used for external notification/verification of various operational conditions such as fault conditions and heating mode status. This relay can be used with building EMS (Energy Management System) and other external supervisory controls.

Output Function

Adjustable user setting. Available options for the Alarm Output Function setting are:

Heating Mode: Used for heating mode on/off status notification.

Enable / Disable Closed: Used for notification and/or verification of the enable/disable circuits open/closed status. There are two enable/disable circuits available for external supervisory control(s) at the J7 socket on the CCB - see wiring diagrams. Enable/disable circuit(s) status can be viewed in the Heater Status Menu.

Temp < Heater SP: Used for external notification when current tank temperature drops below Operating Set Point.

Temp < Alarm SP: Used for external notification when current tank temperature drops below programmable Alarm SP.

Fault or Alert: Used for external notification whenever a Fault or Alert condition is active.

Fault: Used for notification whenever a Fault condition is active.

Disabled: Disables the Alarm Relay Output Function.

Alarm SP

Adjustable user setting (90°F to 190°F) the control system uses for the "Temp < Alarm SP" function described above. This setting has no effect with any other Alarm Output functions.

Alarm Output Settings

Changing the user settings in this menu is done using the same methods for changing the Operating Set Point.

Service Note: Adjustable user settings in the Alarm Output Setup menu are unaffected by Restore Factory Defaults.

DISPLAY SETTINGS MENU

Permits user to set display options for viewing information on the UIM's LCD screen.

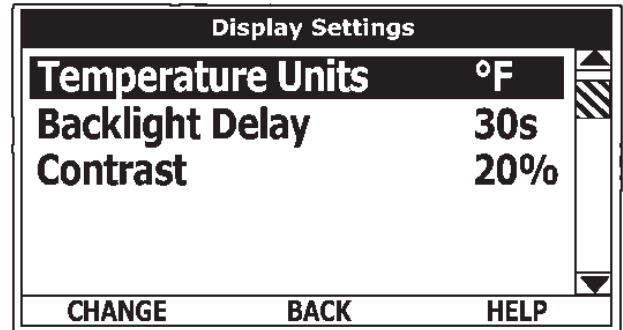

Temperature Units

Adjustable user setting that changes temperature units display to Celsius °C or Fahrenheit °F.

Backlight Delay

Adjustable user setting that determines how long the UIM's LCD backlight remains illuminated after a key has been pressed. Available settings are; Always Off, 10, 30 or 60 seconds and Always On.

Contrast

Adjustable user setting to adjust the UIM's LCD screen contrast between text and background.

Display Settings

Changing the user settings in this menu is done using the same methods for changing the Operating Set Point.

Service Note: Adjustable user settings in the Display Settings menu are unaffected by Restore Factory Defaults.

HEATER INFORMATION MENU

This menu displays non adjustable operational information.

Top of Menu

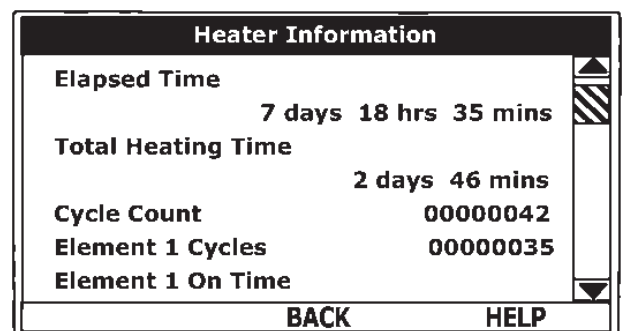

Bottom of Menu

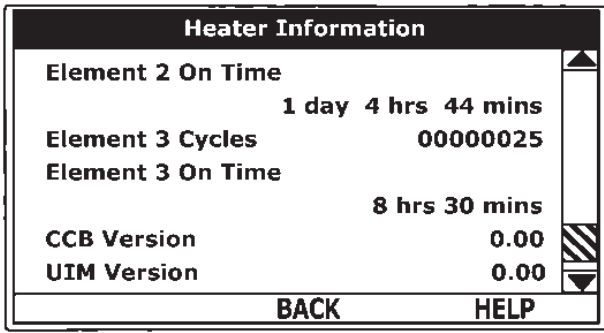

Elapsed Time

Total accumulated time the control system (water heater) has been energized.

Total Heating Time

Total accumulated time the control system has been in the heating mode. IE: any heating elements have been energized.

Element # Cycles

Total accumulated count of heating cycles for each heating element.

Element # On Time

Total accumulated heating on time for each heating element.

CCB Version

Software version for Central Control Board.

UIM Version

Software version for User Interface Module

CURRENT FAULT / ALERT MENU

This menu displays non adjustable operational information. With the Fault History sub menu selected in Main Menu; press the Operational Button underneath "SELECT" to display the current Fault or Alert message. If there is not a Fault or Alert condition currently active "(none)" is displayed to the right of this menu.

Main Menu - Current Fault Selected

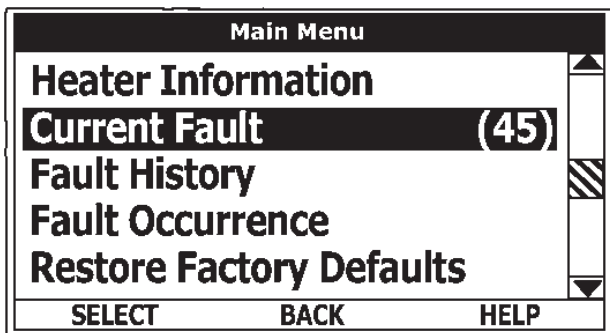

FAULT HISTORY MENU

This menu displays non adjustable operational information. The control system records and stores the last 9 Fault and Alert

messages in chronological order in this menu. The most recent will be at the top of the list. A time stamp is displayed below each listed Fault and Alert message showing when the Fault or Alert condition occurred.

The Fault History is useful when dealing with intermittent operational problems or when the customer has reset the control system prior to a service agent's arrival.

With a Fault or Alert item selected press the Operational Button underneath "VIEW" to display the details for the Fault or Alert message. The Fault/Alert message screen displays a brief description of the condition, contact information and access to the Advanced service information sub menu.

Fault History Menu

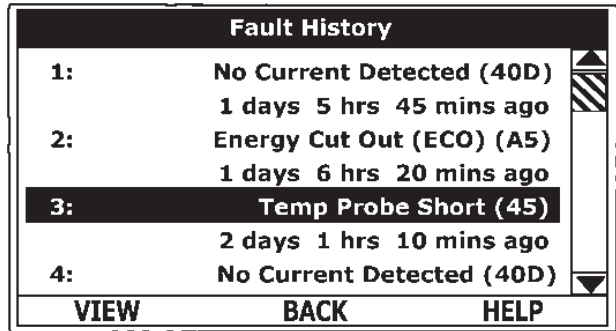

Current/History Fault Message

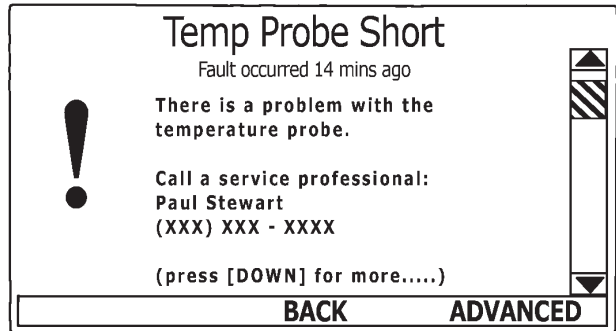

FAULT OCCURRENCE MENU

Total accumulated number each individual Fault condition has occurred is displayed in this menu. This running total of Fault Occurrences can be useful in determining which (if any) operational problems have been persistent.

Fault Occurrence Menu

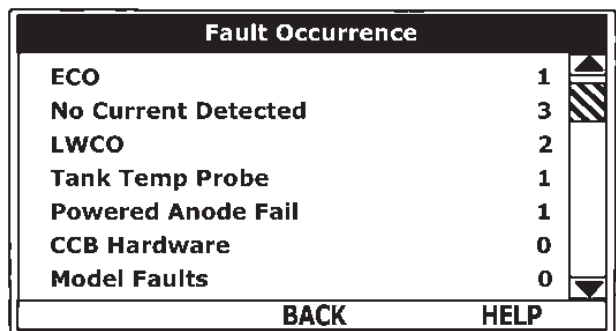

RESTORE FACTORY DEFAULTS MENU

This control system menu allows the user to restore most of the control system's user settings to their factory default settings. **User settings in the Alarm Output Setup and Display Settings menus are unaffected by executing Restore Factory Defaults.**

Restore Factory Defaults

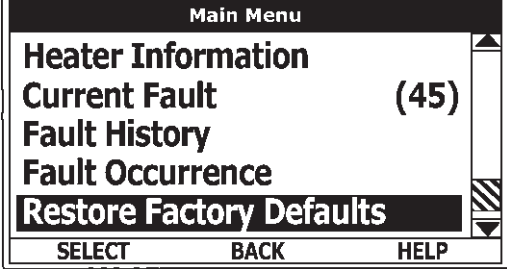
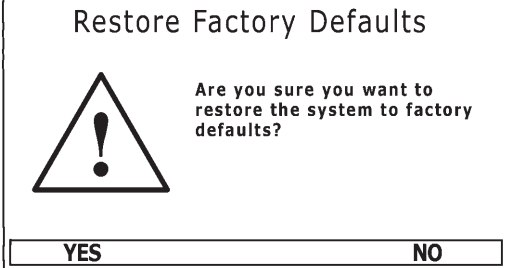
ACTION	DISPLAY
<p>From the Main Menu use the Up/Down buttons to select (highlight in black) the "Restore Factory Defaults" menu.</p> <p>Press the Operational Button underneath "SELECT." The Restore Factory Defaults menu will be displayed.</p>	
<p>From the Restore Factory Defaults menu press the Operational Button underneath "YES." The display will show text confirming the factory default settings have been restored.</p> <p>Press the Operational Button underneath "BACK" to exit the Restore Factory Defaults menu.</p>	

MAINTENANCE

GENERAL

Water heater maintenance includes inspection and testing of the Temperature Pressure Relief Valve, periodic tank flushing and cleaning, and removal of lime scale from the heating elements. Where used, water heating system circulating pumps should be oiled.

Tank flushing and element maintenance should be performed in accordance with the maintenance schedule, see Table 9. Tank sediment removal and element lime scale removal must be performed when needed as determined by periodic inspections.

ANODE INSPECTION AND REPLACEMENT

This water heater is equipped with a sacrificial anode. Sacrificial anodes protect the glass lined tank from corrosion by sacrificing themselves through electrolysis. When the anode material is consumed, there is no more protection and corrosion of the tank accelerates. If equipped, powered anode rods are non sacrificial and should not need to be replaced unless damaged.

Inspection of the sacrificial anode every 6 to 12 months allows you to identify a spent anode and replace it. Replace the anode when its diameter is 3/8" (1 cm) of an inch, or annually whichever is first. Aggressive, very hot and softened water causes rapid consumption of the anode requiring frequent inspections. Call the toll free number on the back cover of this manual for information on obtaining replacement anode rods.

TEMPERATURE-PRESSURE RELIEF VALVE OPERATION

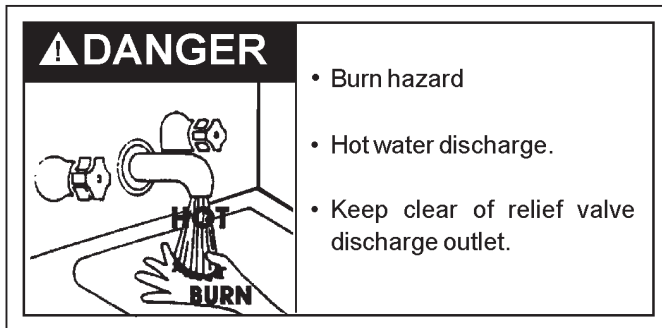

The **TEMPERATURE-PRESSURE RELIEF VALVE** must be manually operated at least once a month. Lift the lever at the top of valve several times until the valve seats properly and operates freely, see Figure 7.

When checking the temperature-pressure relief valve operation, make sure that (1) no one is in front of or around the outlet of the temperature-pressure relief valve discharge line, and (2) that the water discharge will not cause any property damage, as the water may be extremely hot. Use care when operating valve as the valve may be hot.

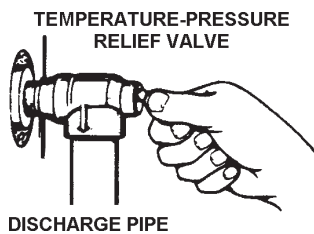

FIGURE 7.

If after manually operating the valve, it fails to completely reset and continues to release water, immediately close the cold water inlet to the water heater, follow the draining instructions in the Start Up section of this manual, and replace the temperature-pressure relief valve with a properly rated/sized new one.

If the temperature-pressure relief valve on the water heater weeps or discharges periodically, this may be due to thermal expansion. Consult your local water supplier or a Qualified Service Agency for further information. **DO NOT PLUG THE TEMPERATURE-PRESSURE RELIEF VALVE.**

Component	Operation	Interval	Required
Tank	Flushing	Monthly	
	Sediment Removal	As Needed	
Elements	Lime Scale Removal	As Needed	UN-LIME delimer and element gaskets

TABLE 9. - MAINTENANCE SCHEDULE.

FLUSHING

The water heater drain valve should be opened periodically to help prevent sediment buildup on the tank bottom.

1. Turn off the electrical disconnect switch.
2. Open a nearby hot water faucet until the water is no longer hot, then close the hot water faucet.
3. Attach hose to outlet opening of drain valve and direct end to drain.
 - Open the drain valve by turning the hand wheel to the left (counterclockwise). Allow water to flow until it runs clean.
 - If water does not flow from opened drain valve, follow instructions for sediment removal.
4. When finished flushing:
 - Close heater drain valve and remove hose.
 - Turn on electricity.

SEDIMENT REMOVAL

Water borne impurities consist of fine particles of soil and sand which settle out and form a layer of sediment on the bottom of the tank. In time, if not removed, the level of sediment might reach the heating elements and cause their failure.

For convenience, sediment removal and element lime scale removal should be performed at the same time as follows.

LIME SCALE REMOVAL

Lime scale accumulations on the heating elements is a normal condition, common to all immersion type elements. Factors which affect the amounts of this formation are:

1. Amount of hot water used. As the volume of the water heated increases, more scale results.
2. Water temperature. As the temperature of the water is increased, more scale is deposited on the elements.

3. Characteristics of water supply.

Regardless of water treatment, the elements should be examined regularly.

Lime scale accumulations may cause noises to occur during operation.

It is recommended that a heating element be removed periodically for examination. If it is scaled, all of the elements should be removed and cleaned. If the tank bottom has an accumulation of sediment it should be cleaned.

Lime scale should be removed by dissolving the accumulation in UN-LIME® delimer. Do not use muriatic or hydrochloric acid base deliming solutions to remove lime scale from the elements.

THE PROCESS FOR LIME SCALE REMOVAL IS AS FOLLOWS:

1. Turn off electrical disconnect switch.
2. Drain the heater following DRAINING instructions.
3. Open front panel.
4. Disconnect the element wiring. Try not to disturb the wiring unnecessarily and reconnection will be easier.
5. Unscrew each element.
6. Remove the elements and gaskets from the openings.
 - Use a twisting, pulling action to remove elements scaled beyond the size of the tank openings.
 - Brush loose scale from elements.
7. Lime scale removal:
 - Place limed ends of heating elements into UN-LIME delimer

and allow scale to dissolve. Do not permit delimer or water to contact heating element electrical terminals.

- Silicates, sulfates, and aluminates must be removed by scraping or other mechanical means. Lime scale dissolvents will not remove these types of scale which are occasionally encountered.

8. Flush cleaned ends of elements with water when deliming or cleaning is completed.

Call the toll free phone number on the back cover of this Instruction Manual to purchase UN-LIME and heating element gaskets.

OTHER SCALE REMOVAL:

1. Remove sediment and scale from the tank bottom through the access provided by the element openings or drain valve opening.
 - The cold water inlet valve and drain valve may be opened to aid the cleanout process.
2. Clean remaining gasket material from tank and element flanges. Don not reuse original element gaskets.
3. Put new gaskets on each element and install into tank openings.
 - Uniformly tighten element bolts. Torque to approximately 32 ft/lbs.
4. Attach element wires to connection points from which they were removed.
5. Follow FILLING instructions to restore hot water service.
 - Check for water leaks around elements and proper operation when heater is filled.
 - Close the panel.

TROUBLESHOOTING CHECKLIST

Before calling for service, check the following points to see if the cause of trouble can be identified and corrected. Reviewing this checklist may eliminate the need of a service call and quickly restore hot water service.

The illustration in the Features and Components section of this manual identifies the location of most of the heater components.

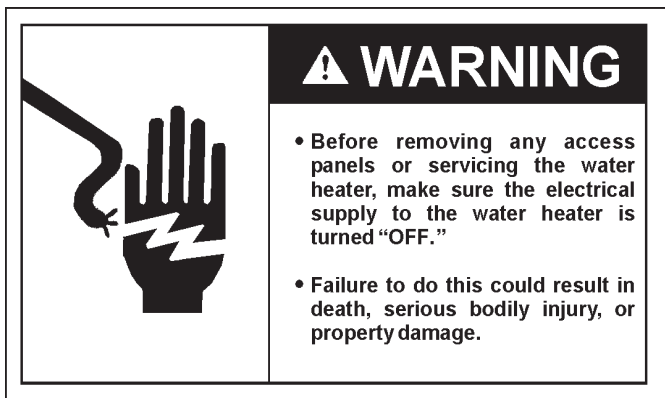

BE SURE TO TURN OFF THE ELECTRICITY (ELECTRICAL DISCONNECT SWITCH) WHEN CHECKING EQUIPMENT.

NOT ENOUGH OR NO HOT WATER

1. Be certain the electrical disconnect switch serving the water heater is in the ON position. The pilot toggle switch on the cabinet should be ON.

In some areas water heater electrical service may be limited by the power company. If the heater operates on a controlled circuit, heater recovery may be affected.

The optional manual override switches on the cabinet front may be turned off, de-energizing the elements.

2. Check the fuses.

The electrical disconnect switch usually contains fuses.

The water heater has fuses located behind the cabinet front door, see the Features and Components section of this manual for their location.

3. If the water was excessively hot, and is now cold, the ECO high limit switch may have activated.

- See the Temperature Regulation section of this manual for more information on how to reset the ECO high limit controls.

Repeated activation of the ECO high limit switch should be investigated by a Qualified Service Agent.

4. The storage capacity and/or recovery rate of the water heater may have been exceeded by a large demand for hot water. See the Recovery Data tables in this manual.

Large demands require a recovery period to restore water temperature.

5. Cold incoming water temperature will lengthen the time required to heat water to the desired temperature.

If the heater was installed when incoming water temperature was warm, colder water creates the effect of less hot water.

7. Sediment or lime scale may be affecting water heater operation. Refer to the MAINTENANCE section of this manual for details.

WATER IS TOO HOT

Refer to the TEMPERATURE REGULATION section of this manual.

WATER HEATER MAKES STRANGE SOUNDS

1. Sediment or lime scale accumulations on the elements causes sizzling and hissing noises when the heater is operating.

The sounds are normal, however, the tank bottom and elements should be cleaned. Refer to MAINTENANCE section of this manual for details.

2. Some of the electrical components of the water heater make sounds which are normal ie. contactors will "Click" or snap as the heater starts and stops.

LEAKAGE CHECKPOINTS

1. Check to see if the drain valve is tightly closed.
2. The apparent leakage may be condensation which forms on cool surfaces of the heater and piping.
3. If the outlet of the relief valve is leaking it may represent:

- Excessive water pressure.
- Excessive water temperature.
- Faulty temperature and pressure relief valve.

Excessive water pressure is the most common cause of relief valve leakage. Water supply systems may, because of code requirements or such conditions as high line pressure, among others, have installed devices such as pressure reducing valves, check valves, and back flow preventers. Devices such as these cause the water system to be a closed system.

As water is heated, it expands (thermal expansion). In a closed system the volume of water will grow when it is heated. As the volume of water grows there will be a corresponding increase in water pressure due to thermal expansion. Thermal expansion can cause intermittent temperature-pressure relief valve operation: water discharged from the valve due to excessive pressure build up. This condition is not covered under the limited warranty. The temperature-pressure relief valve is not intended for the constant relief of thermal expansion.

A properly sized thermal expansion tank should be installed on all closed systems to control the harmful effects of thermal expansion. Contact a local qualified service agency to have a thermal expansion tank installed.

4. Examine the flange area of the elements for gasket leakage.

Tighten the bolts or, if necessary, follow the WATER AND LIME SCALE REMOVAL procedure in the MAINTENANCE section of this manual to replace the gaskets.









IF YOU CANNOT IDENTIFY OR CORRECT THE SOURCE OF MALFUNCTION:

1. Place the water heater electrical disconnect switch in the OFF position.
2. Close the cold water inlet valve to the heater.
3. Call the toll free number on the back cover of this manual for further assistance.

COMMERCIAL ELECTRIC - (1 UNIT)

WARNING: THIS DRAWING SHOWS SUGGESTED PIPING CONFIGURATION AND OTHER DEVICES; CHECK WITH LOCAL CODES AND ORDINANCES FOR ADDITIONAL REQUIREMENTS.

LEGEND

	TEMPERATURE & PRESSURE RELIEF VALVE		FULL PORT BALL VALVE
	PRESSURE RELIEF VALVE		CHECK VALVE
	CIRCULATING PUMP		TEMPERATURE GAGE
	TANK TEMPERATURE CONTROL		WATER FLOW SWITCH
	DRAIN		

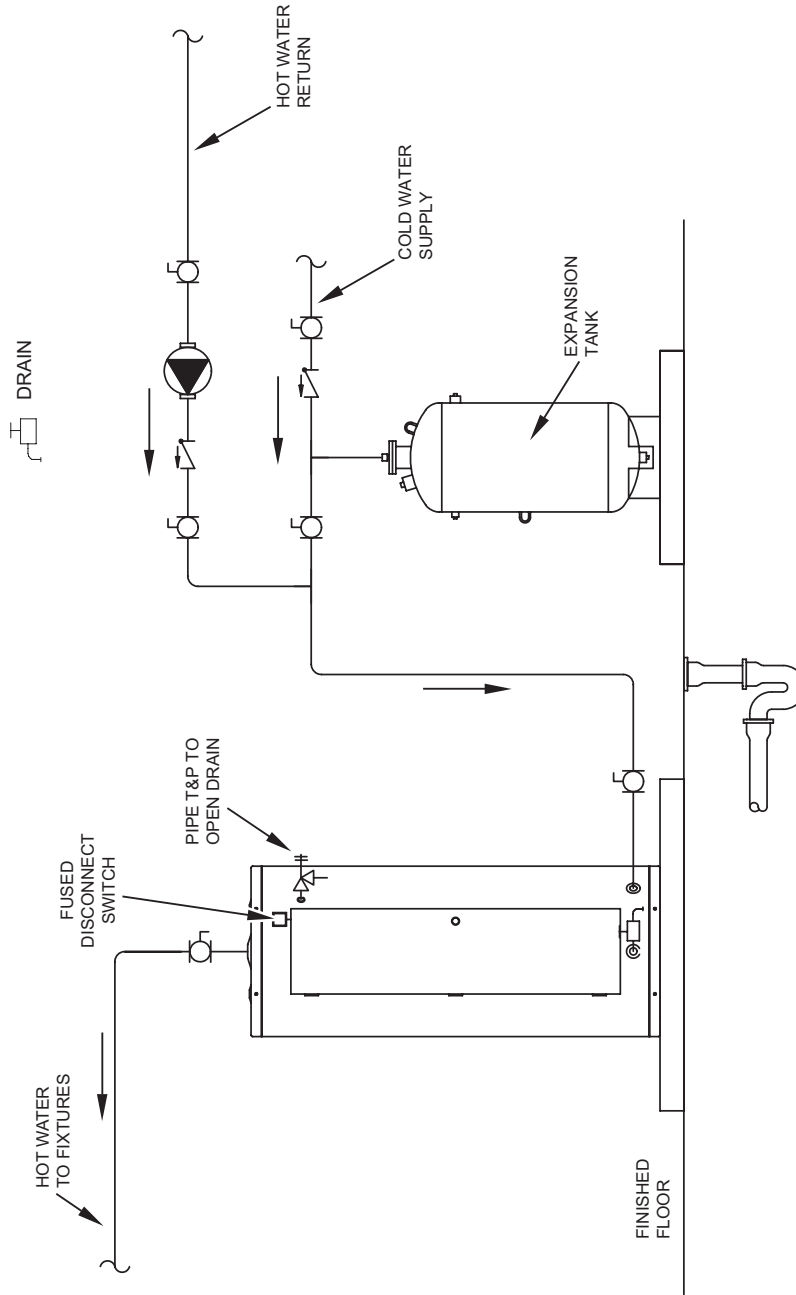

NOTES:

1. Preferred piping diagram.
2. The temperature and pressure relief valve setting shall not exceed pressure rating of any component in the system.
3. Service valves are shown for servicing unit. However, local codes shall govern their usage.

COMMERCIAL ELECTRIC - (1 UNIT) WITH VERTICAL STORAGE TANK

WARNING: THIS DRAWING SHOWS SUGGESTED PIPING CONFIGURATION AND OTHER DEVICES; CHECK WITH LOCAL CODES AND ORDINANCES FOR ADDITIONAL REQUIREMENTS.

LEGEND

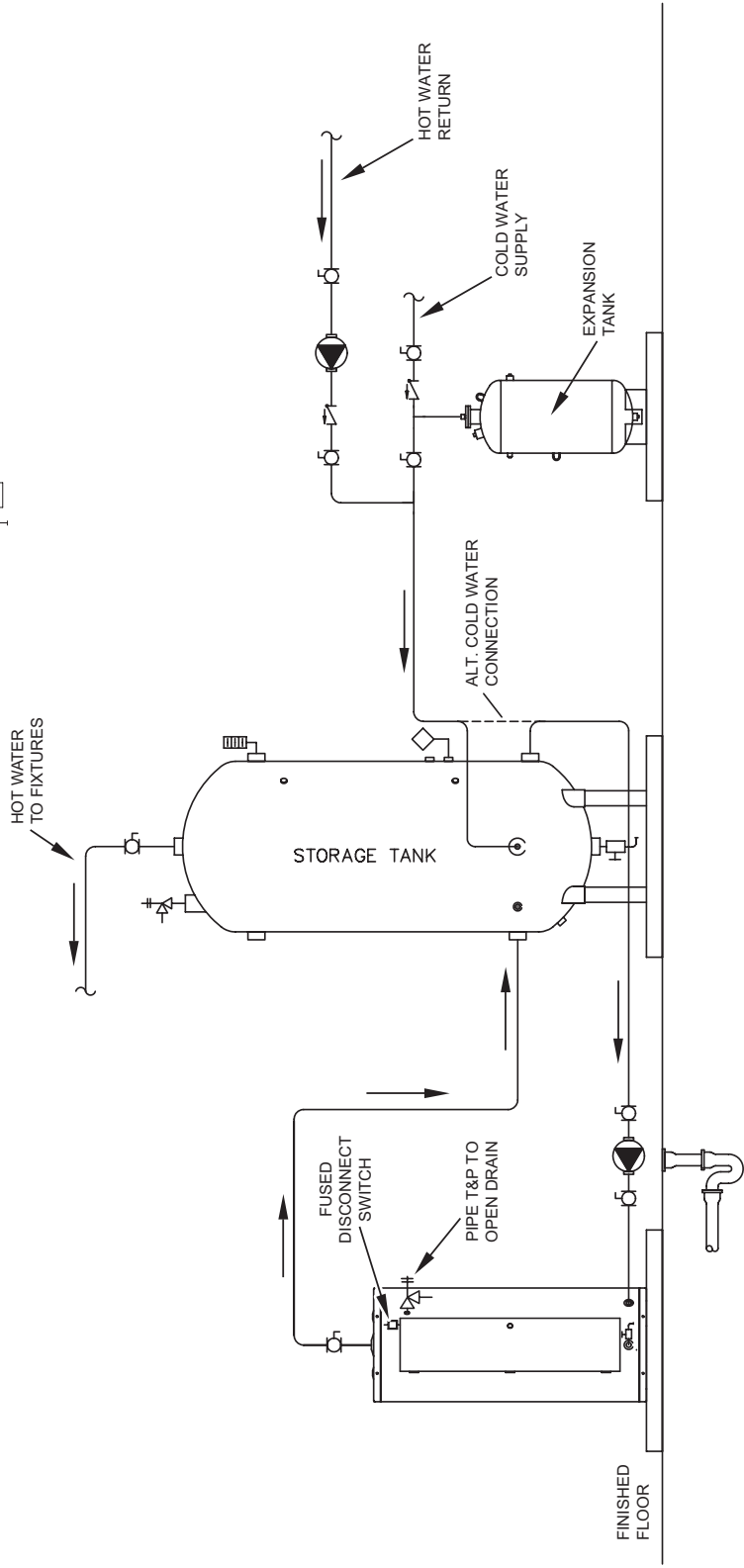
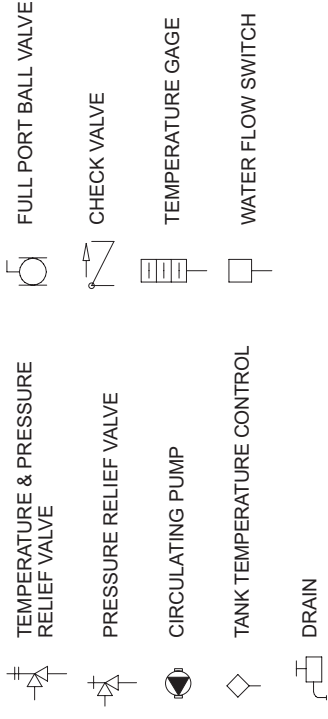









NOTES:

1. Preferred piping diagram.
2. The temperature and pressure relief valve setting shall not exceed pressure rating of any component in the system.
3. Service valves are shown for servicing unit. However, local codes shall govern their usage.
4. The Tank Temperature Control should be wired to and control the pump between the water heater(s) and the storage tank(s).
5. The water heater's operating thermostat should be set 5 degrees F higher than the Tank Temperature Control.

COMMERCIAL ELECTRIC - (1 UNIT) WITH HORIZONTAL STORAGE TANK

WARNING: THIS DRAWING SHOWS SUGGESTED PIPING CONFIGURATION AND OTHER DEVICES; CHECK WITH LOCAL CODES AND ORDINANCES FOR ADDITIONAL REQUIREMENTS.

LEGEND

	TEMPERATURE & PRESSURE RELIEF VALVE		FULL PORT BALL VALVE
	PRESSURE RELIEF VALVE		CHECK VALVE
	CIRCULATING PUMP		TEMPERATURE GAGE
	TANK TEMPERATURE CONTROL		WATER FLOW SWITCH
	DRAIN		

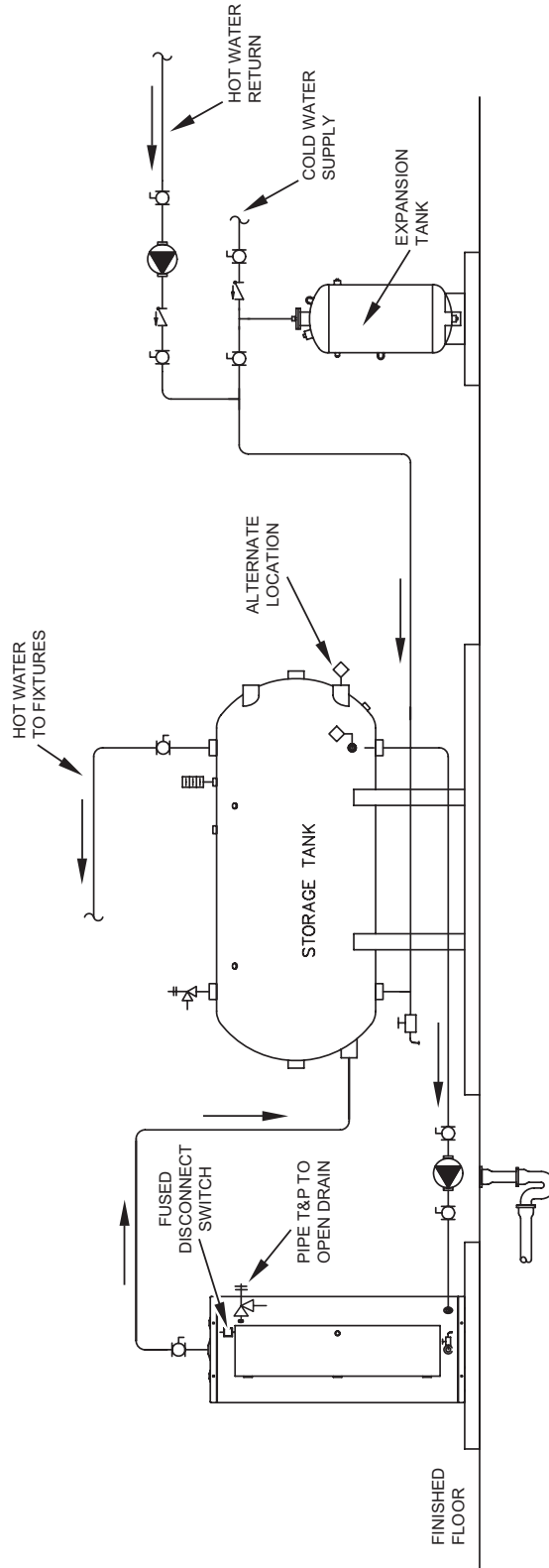









NOTES:

1. Preferred piping diagram.
2. The temperature and pressure relief valve setting shall not exceed pressure rating of any component in the system.
3. Service valves are shown for servicing unit. However, local codes shall govern their usage.
4. The Tank Temperature Control should be wired to and control the pump between the water heater(s) and the storage tank(s).
5. The water heater's operating thermostat should be set 5 degrees F higher than the Tank Temperature Control.

COMMERCIAL ELECTRIC - (2 UNITS)

WARNING: THIS DRAWING SHOWS SUGGESTED PIPING CONFIGURATION AND OTHER DEVICES; CHECK WITH LOCAL CODES AND ORDINANCES FOR ADDITIONAL REQUIREMENTS.

LEGEND

	TEMPERATURE & PRESSURE RELIEF VALVE		FULL PORT BALL VALVE
	PRESSURE RELIEF VALVE		CHECK VALVE
	CIRCULATING PUMP		TEMPERATURE GAGE
	TANK TEMPERATURE CONTROL		WATER FLOW SWITCH
	DRAIN		

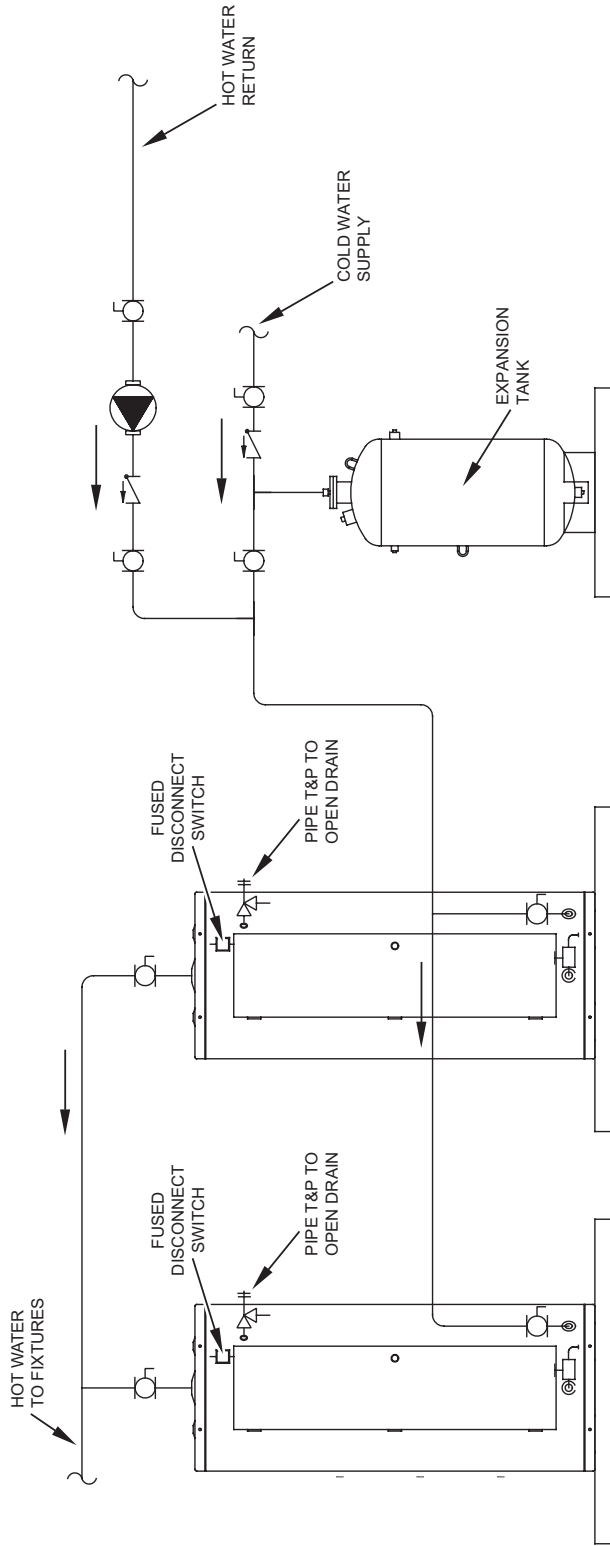









NOTES:

1. Preferred piping diagram.
2. The temperature and pressure relief valve setting shall not exceed pressure rating of any component in the system.
3. Service valves are shown for servicing unit. However, local codes shall govern their usage.

COMMERCIAL ELECTRIC - (2 UNITS) WITH VERTICAL STORAGE TANK

WARNING: THIS DRAWING SHOWS SUGGESTED PIPING CONFIGURATION AND OTHER DEVICES; CHECK WITH LOCAL CODES AND ORDINANCES FOR ADDITIONAL REQUIREMENTS.

LEGEND

	TEMPERATURE & PRESSURE RELIEF VALVE		FULL PORT BALL VALVE
	PRESSURE RELIEF VALVE		CHECK VALVE
	CIRCULATING PUMP		TEMPERATURE GAGE
	TANK TEMPERATURE CONTROL		WATER FLOW SWITCH
	DRAIN		

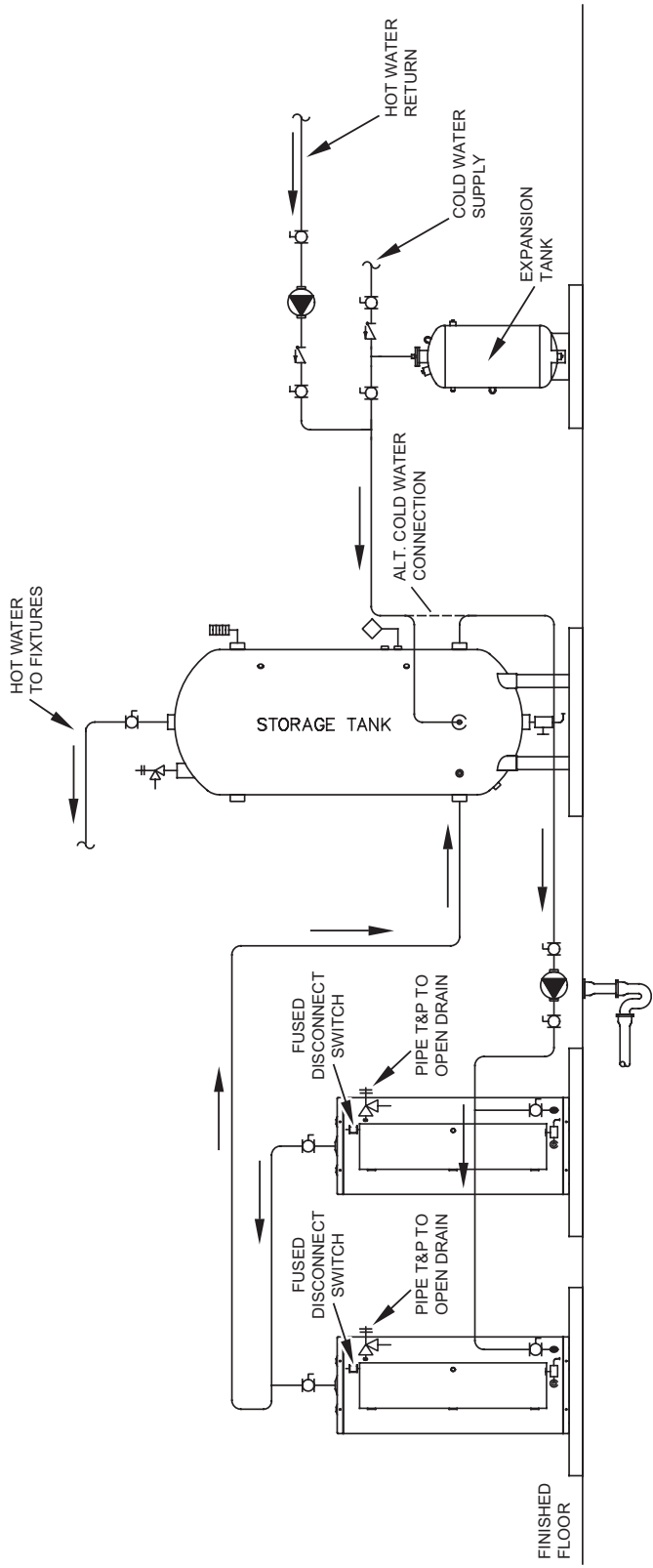

NOTES:

1. Preferred piping diagram.
2. The temperature and pressure relief valve setting shall not exceed pressure rating of any component in the system.
3. Service valves are shown for servicing unit. However, local codes shall govern their usage.
4. The Tank Temperature Control should be wired to and control the pump between the water heater(s) and the storage tank(s).
5. The water heater's operating thermostat should be set 5 degrees F higher than the Tank Temperature Control.

COMMERCIAL ELECTRIC - (2 UNITS) WITH HORIZONTAL STORAGE TANK

WARNING: THIS DRAWING SHOWS SUGGESTED PIPING CONFIGURATION AND OTHER DEVICES; CHECK WITH LOCAL CODES AND ORDINANCES FOR ADDITIONAL REQUIREMENTS.

LEGEND

- TEMPERATURE & PRESSURE RELIEF VALVE
- PRESSURE RELIEF VALVE
- CIRCULATING PUMP
- TANK TEMPERATURE CONTROL
- DRAIN
- FULL PORT BALL VALVE
- CHECK VALVE
- TEMPERATURE GAGE
- WATER FLOW SWITCH

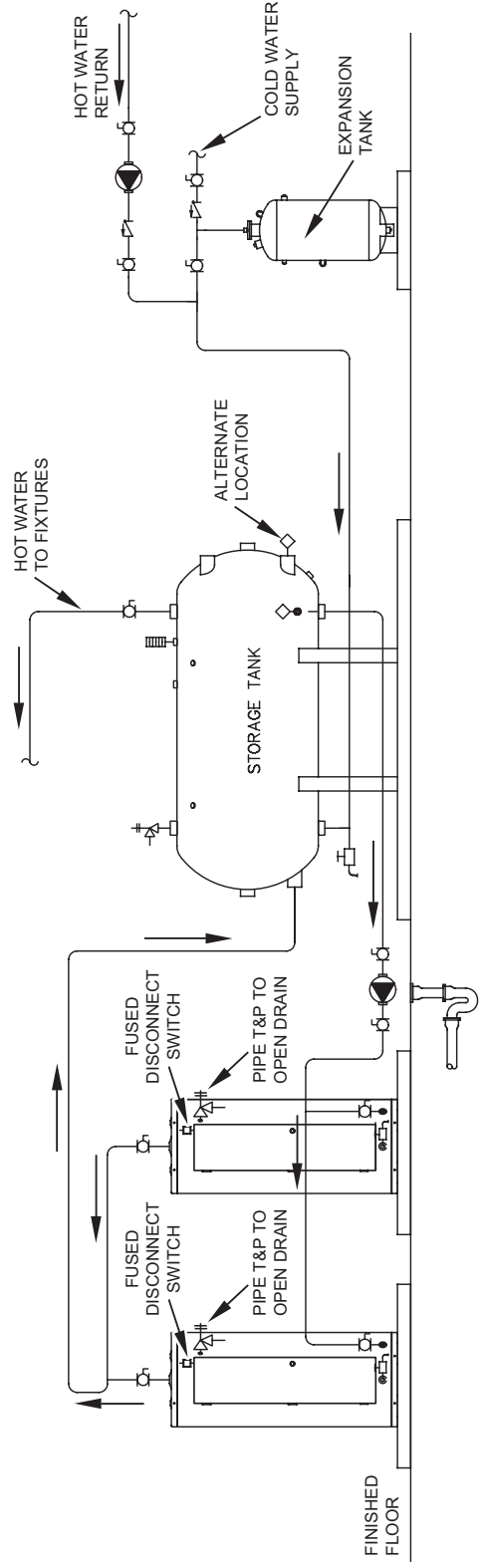









NOTES:

1. Preferred piping diagram.
2. The temperature and pressure relief valve setting shall not exceed pressure rating of any component in the system.
3. Service valves are shown for servicing unit. However, local codes shall govern their usage.
4. The Tank Temperature Control should be wired to and control the pump between the water heater(s) and the storage tank(s).
5. The water heater's operating thermostat should be set 5 degrees F higher than the Tank Temperature Control.

COMMERCIAL ELECTRIC - (3 UNITS)

WARNING: THIS DRAWING SHOWS SUGGESTED PIPING CONFIGURATION AND OTHER DEVICES; CHECK WITH LOCAL CODES AND ORDINANCES FOR ADDITIONAL REQUIREMENTS.

LEGEND

	TEMPERATURE & PRESSURE RELIEF VALVE		FULL PORT BALL VALVE
	PRESSURE RELIEF VALVE		CHECK VALVE
	CIRCULATING PUMP		TEMPERATURE GAGE
	TANK TEMPERATURE CONTROL		WATER FLOW SWITCH
	DRAIN		

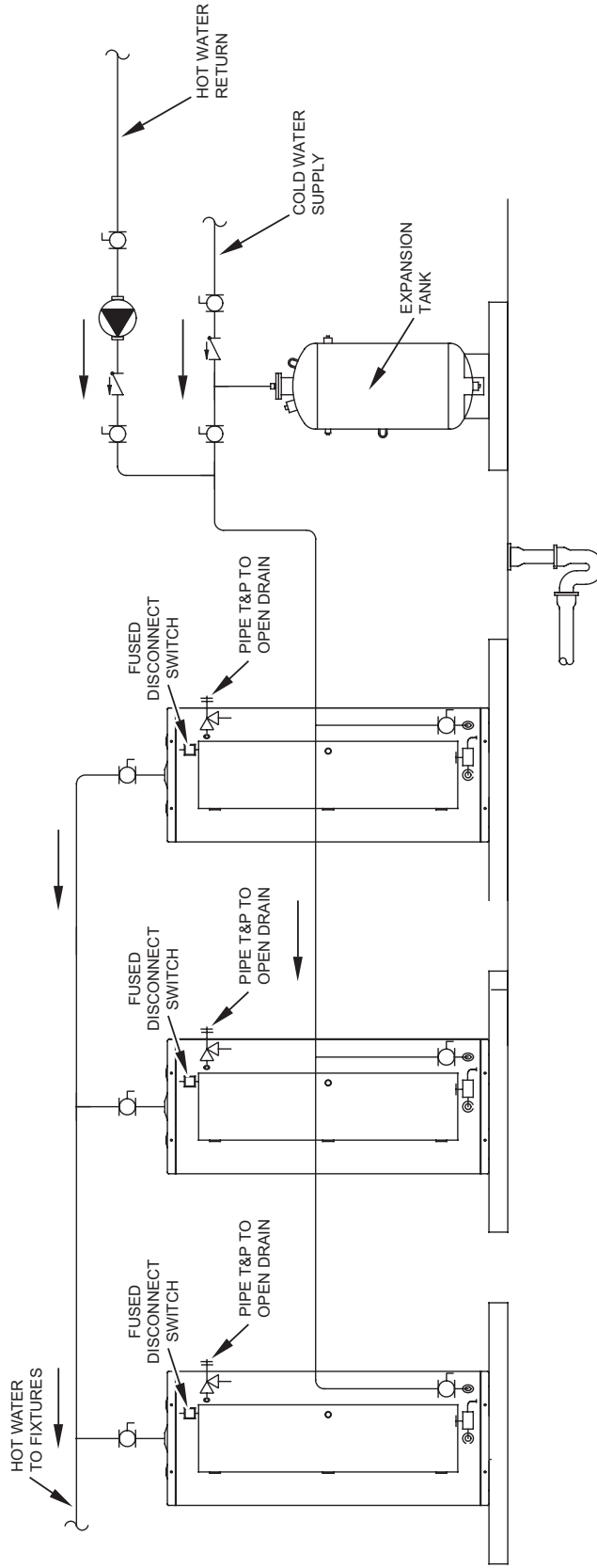









- NOTES:**
1. Preferred piping diagram.
 2. The temperature and pressure relief valve setting shall not exceed pressure rating of any component in the system.
 3. Service valves are shown for servicing unit. However, local codes shall govern their usage.

COMMERCIAL ELECTRIC - (3 UNITS) WITH VERTICAL STORAGE TANK

WARNING: THIS DRAWING SHOWS SUGGESTED PIPING CONFIGURATION AND OTHER DEVICES; CHECK WITH LOCAL CODES AND ORDINANCES FOR ADDITIONAL REQUIREMENTS.

LEGEND



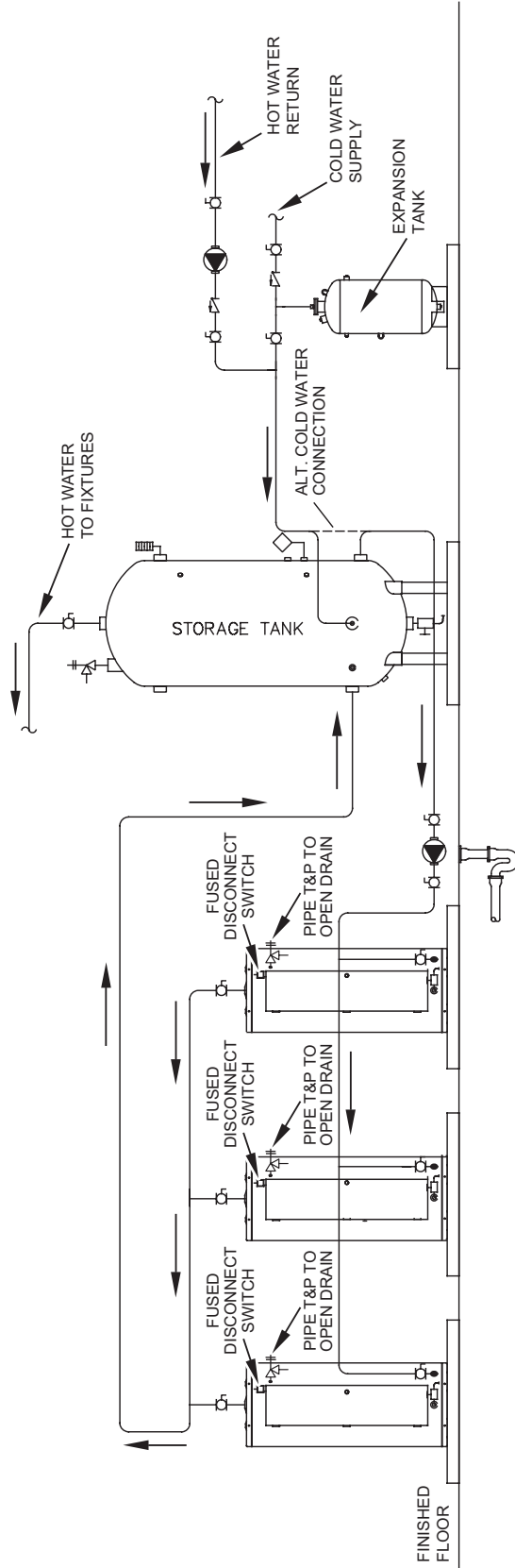





	TEMPERATURE & PRESSURE RELIEF VALVE		FULL PORT BALL VALVE
	PRESSURE RELIEF VALVE		CHECK VALVE
	CIRCULATING PUMP		TEMPERATURE GAGE
	TANK TEMPERATURE CONTROL		WATER FLOW SWITCH
	DRAIN		



NOTES:

1. Preferred piping diagram.
2. The temperature and pressure relief valve setting shall not exceed pressure rating of any component in the system.
3. Service valves are shown for servicing unit. However, local codes shall govern their usage.
4. The Tank Temperature Control should be wired to and control the pump between the water heater(s) and the storage tank(s).
5. The water heater's operating thermostat should be set 5 degrees F higher than the Tank Temperature Control.

LEGEND

	TEMPERATURE & PRESSURE RELIEF VALVE		FULL PORT BALL VALVE
	PRESSURE RELIEF VALVE		CHECK VALVE
	CIRCULATING PUMP		TEMPERATURE GAGE
	TANK TEMPERATURE CONTROL		WATER FLOW SWITCH
	DRAIN		

COMMERCIAL ELECTRIC - (3 UNITS) WITH HORIZONTAL STORAGE TANK

WARNING: THIS DRAWING SHOWS SUGGESTED PIPING CONFIGURATION AND OTHER DEVICES; CHECK WITH LOCAL CODES AND ORDINANCES FOR ADDITIONAL REQUIREMENTS.

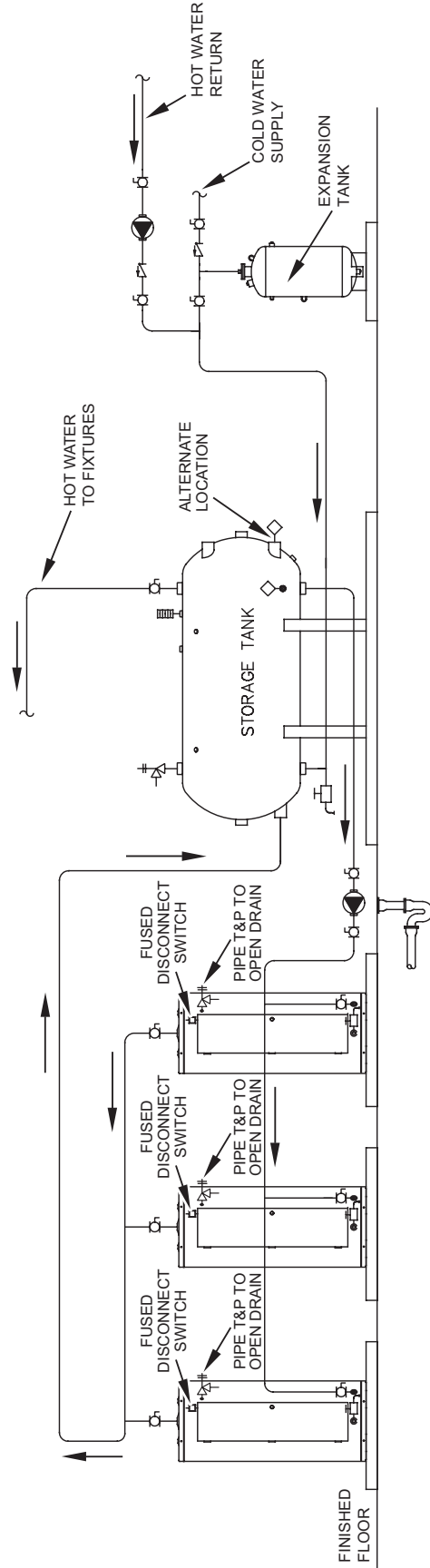









NOTES:

1. Preferred piping diagram.
2. The temperature and pressure relief valve setting shall not exceed pressure rating of any component in the system.
3. Service valves are shown for servicing unit. However, local codes shall govern their usage.
4. The Tank Temperature Control should be wired to and control the pump between the water heater(s) and the storage tank(s).
5. The water heater's operating thermostat should be set 5 degrees F higher than the Tank Temperature Control.

COMMERCIAL ELECTRIC - (4 UNITS)

WARNING: THIS DRAWING SHOWS SUGGESTED PIPING CONFIGURATION AND OTHER DEVICES; CHECK WITH LOCAL CODES AND ORDINANCES FOR ADDITIONAL REQUIREMENTS.

LEGEND

	TEMPERATURE & PRESSURE RELIEF VALVE		FULL PORT BALL VALVE
	PRESSURE RELIEF VALVE		CHECK VALVE
	CIRCULATING PUMP		TEMPERATURE GAGE
	TANK TEMPERATURE CONTROL		WATER FLOW SWITCH
	DRAIN		

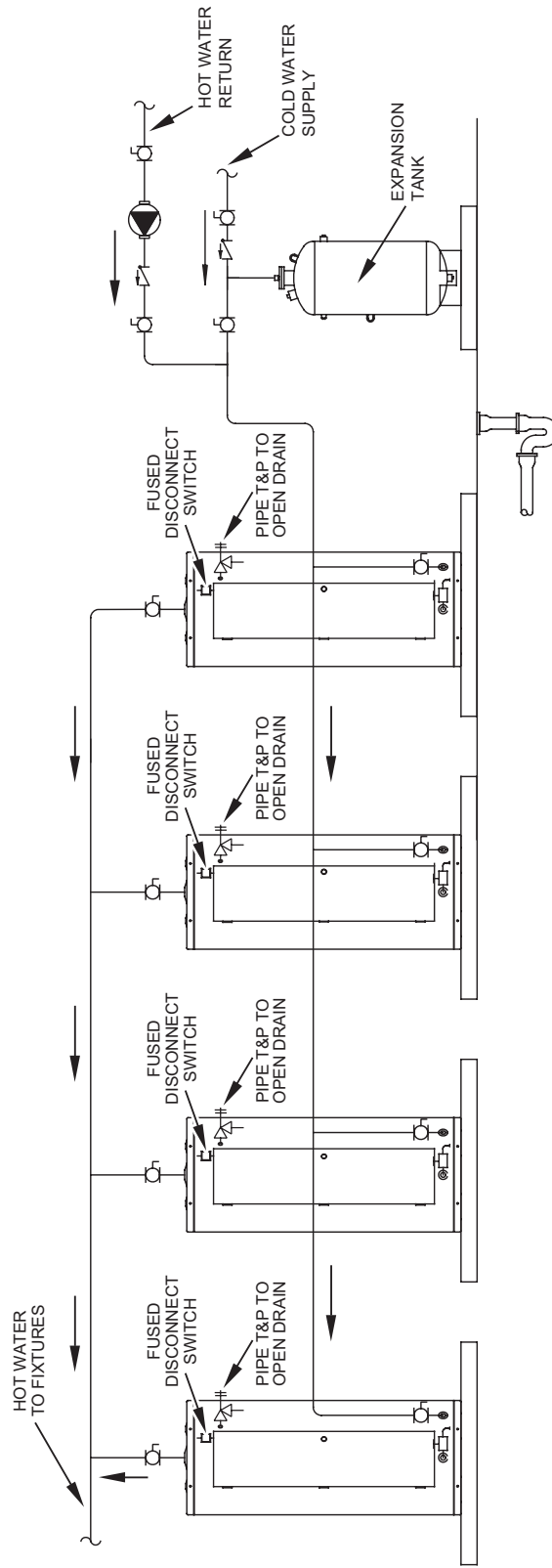

NOTES:

1. Preferred piping diagram.
2. The temperature and pressure relief valve setting shall not exceed pressure rating of any component in the system.
3. Service valves are shown for servicing unit. However, local codes shall govern their usage.

LEGEND

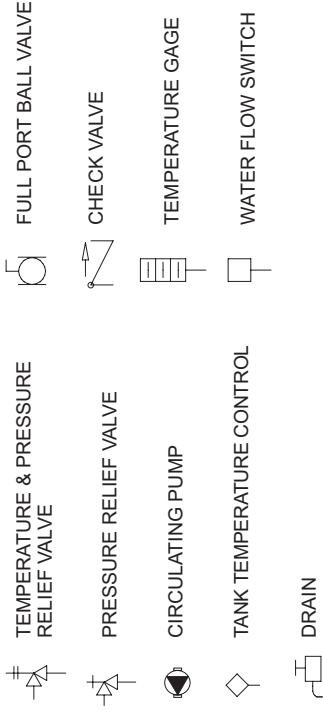

COMMERCIAL ELECTRIC - (4 UNITS) WITH VERTICAL STORAGE TANK



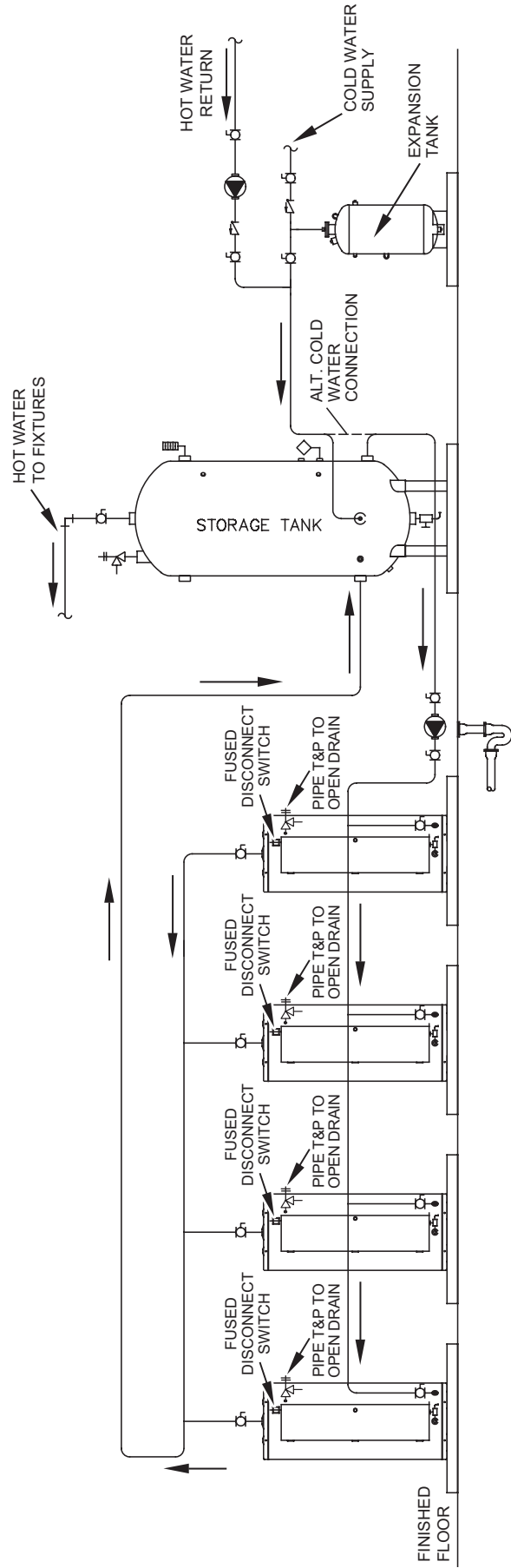





WARNING: THIS DRAWING SHOWS SUGGESTED PIPING CONFIGURATION AND OTHER DEVICES; CHECK WITH LOCAL CODES AND ORDINANCES FOR ADDITIONAL REQUIREMENTS.



NOTES:

1. Preferred piping diagram.
2. The temperature and pressure relief valve setting shall not exceed pressure rating of any component in the system.
3. Service valves are shown for servicing unit. However, local codes shall govern their usage.
4. The Tank Temperature Control should be wired to and control the pump between the water heater(s) and the storage tank(s).
5. The water heater's operating thermostat should be set 5 degrees F higher than the Tank Temperature Control.

LEGEND

	TEMPERATURE & PRESSURE RELIEF VALVE		FULL PORT BALL VALVE
	PRESSURE RELIEF VALVE		CHECK VALVE
	CIRCULATING PUMP		TEMPERATURE GAGE
	TANK TEMPERATURE CONTROL		WATER FLOW SWITCH
	DRAIN		

COMMERCIAL ELECTRIC - (4 UNITS) WITH HORIZONTAL STORAGE TANK

WARNING: THIS DRAWING SHOWS SUGGESTED PIPING CONFIGURATION AND OTHER DEVICES; CHECK WITH LOCAL CODES AND ORDINANCES FOR ADDITIONAL REQUIREMENTS.

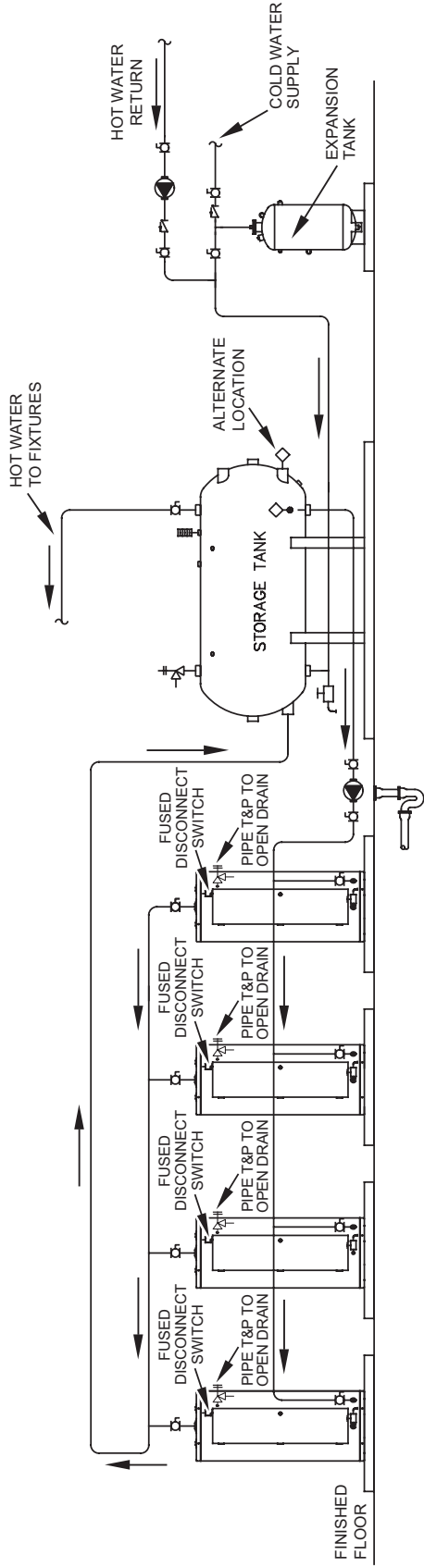

NOTES:

1. Preferred piping diagram.
2. The temperature and pressure relief valve setting shall not exceed pressure rating of any component in the system.
3. Service valves are shown for servicing unit. However, local codes shall govern their usage.
4. The Tank Temperature Control should be wired to and control the pump between the water heater(s) and the storage tank(s).
5. The water heater's operating thermostat should be set 5 degrees F higher than the Tank Temperature Control.

WARRANTY

State Water Heaters, the warrantor, extends the following LIMITED WARRANTY to the owner of this water heater:

1. THE TANK

If the glass-lined tank in this water heater shall prove upon examination by the warrantor to have leaked due to natural corrosion from potable water therein, during the first THREE years after initial installation, the warrantor will supply a complete new State water heater of equivalent size and current model. Some government agencies are requiring energy efficient standards for water heaters. In the event regulations prohibit sale of a model of equivalent size and construction, State will provide a model which complies with the regulations of your area, in which case the consumer will be charged the difference in price between the like replacement and the energy efficient model required. The warranty on the replacement water heater will be limited to the unexpired term of the original warranty.

2. ALL OTHER PARTS

If within ONE year after initial installation of this water heater, any part or portion shall prove upon examination by the warrantor to be defective in material or workmanship, the warrantor will repair or replace such part or portion at its option.

3. CONDITIONS and EXCEPTIONS

This warranty shall apply only when the water heater is installed in accordance with local plumbing and building codes, ordinances and regulations, the printed instructions provided with it and good industry practices. In addition, a temperature and pressure relief valve, certified by A.G.A. and approved by the American Society of Mechanical Engineers, must have been installed.

- a. This warranty shall apply only when the heater is used:
 - (1) at temperatures not exceeding the maximum setting of its thermostat;
 - (2) at water pressure not exceeding the working pressure shown on the water heater;
 - (3) when filled with potable water, free to circulate at all times;
 - (4) in a noncorrosive and non-contaminated atmosphere;
 - (5) in the United States, its territories or possessions, and Canada.
 - (6) used with factory approved anode(s) installed;
 - (7) in its original installation location;
 - (8) sized in accordance with proper sizing techniques for commercial water heaters;
 - (9) bearing a rating plate which has not been altered, defaced or removed except as required by the warrantor;
 - (10) not used in a closed system without a properly sized and installed thermal expansion tank;
 - (11) fired at the proper voltage and wattage;
 - (12) maintained in accordance with the instructions printed in the manual included with the heater.
- b. Any accident to the water heater, any misuse, abuse (including freezing) or alteration of it, any operation of it in a modified form, or any attempt to repair tank leaks will void this warranty.

4. SERVICE and REPAIR EXPENSE

Under this limited warranty the warrantor will provide only a replacement water heater or part thereof. The owner is responsible for all other costs. Such costs may include but are not limited to:

- a. Labor charges for service, removal, repair, or reinstallation of the water heater or any component part;
- b. Shipping, delivery, handling, and administrative charges for forwarding the new heater or replacement part from the nearest distributor and returning the claimed defective heater or part to such distributor;
- c. All cost necessary or incidental for any materials and/or permits required for installation of the replacement heater or part.

5. LIMITATIONS ON IMPLIED WARRANTIES

Implied warranties, including any warranty of merchantability imposed on the sale of this heater under state law are limited to one (1) year duration for the heater or any of its parts. Some states do not allow limitations on how long an implied warranty lasts, so the above limitation may not apply to you.

6. CLAIM PROCEDURE

Any claim under this warranty should be initiated with the dealer who sold the heater, or with any other dealer handling the warrantor's products. If this is not practicable, the owner should contact:

State Water Heaters
500 Tennessee Waltz Parkway
Ashland City, TN 37015
Telephone: (800) 365-0577
website: www.statewaterheaters.com

- a. The warrantor will only honor replacement with identical or similar water heater or parts thereof which are manufactured or distributed by the warrantor.
- b. Dealer replacements are made subject to in-warranty validation by warrantor.

7. DISCLAIMERS

NO OTHER EXPRESS WARRANTY HAS BEEN OR WILL BE MADE IN BEHALF OF THE WARRANTOR WITH RESPECT TO THE MERCHANTABILITY OF THE HEATER OR THE INSTALLATION, OPERATION, REPAIR, OR REPLACEMENT OF THE HEATER. THE WARRANTOR SHALL NOT BE RESPONSIBLE FOR WATER DAMAGE, LOSS OF USE OF THE UNIT, INCONVENIENCE, LOSS OR DAMAGE TO PERSONAL PROPERTY, OR OTHER CONSEQUENTIAL DAMAGE. THE WARRANTOR SHALL NOT BE LIABLE BY VIRTUE OF THIS WARRANTY OR OTHERWISE FOR DAMAGE TO ANY PERSONS OR PROPERTY, WHETHER DIRECT OR INDIRECT, AND WHETHER ARISING IN CONTRACT OR IN TORT.

- a. Some states do not allow the exclusion or limitation of the incidental or consequential damage, so the above limitation or exclusion may not apply to you.
- b. This warranty gives you specific legal rights, and you may also have other rights which vary from state to state.

Fill in the following for your own reference. Keep it. Registration is not a condition of warranty. The model and serial number are found on the heater's rating plate.

Model No. _____ Serial No. _____ Date Installed _____

Dealer's Name _____

Dealer's Address _____ Phone No. _____

City and State _____ Zip _____



Technical Support and Parts: 800 365-0577
www.statewaterheaters.com