

COMMERCIAL STORAGE TANK



LOW LEAD
CONTENT



HLW



U
OPTIONAL



⚠️ WARNING

Read and understand this instruction manual and the safety messages herein before installing, operating or servicing this storage tank.

Failure to follow these instructions and safety messages could result in death or serious injury.

This manual must remain with the storage tank.

ALL TECHNICAL AND WARRANTY QUESTIONS: SHOULD BE DIRECTED TO THE LOCAL DEALER FROM WHOM THE STORAGE TANK WAS PURCHASED. IF YOU ARE UNSUCCESSFUL, CALL THE TECHNICAL SUPPORT PHONE NUMBER SHOWN ON THE STORAGE TANK LABELING.

**KEEP THIS MANUAL IN THE POCKET ON THE STORAGE TANK FOR FUTURE REFERENCE
WHENEVER MAINTENANCE ADJUSTMENT OR SERVICE IS REQUIRED.**

CONTENTS





SAFE INSTALLATION, USE AND SERVICE.....	3	Piping The Temperature-Pressure Relief Valve.....	10
APPROVALS	3	Drain.....	10
GENERAL SAFETY INFORMATION.....	4	Completing Installation	10
Tank Construction.....	4	OPERATION.....	11
INSTALLATION	5	Tank Pre-Start Flush	11
Transporting and Unpacking the Unit	5	Startup Procedure	11
Examining the Unit	5	Shutdown Procedure.....	11
Anchoring the Unit.....	5	INSPECTION.....	12
Recommended Service Clearances.....	5	MAINTENANCE	13
Connecting the Water Source	5	Flushing The Storage Tank	13
Water Piping Diagrams.....	6	Cleaning The Storage Tank	13
Water Supply	10	Magnesium Anode Rod Inspection	14
Water Outlet	10	Water Piping And Valve Replacement	14
Mixing Valve	10	Temperature / Pressure Gauge (Optional) Replacement	
Aquastat / Remote Temperature Sensor (Tank Temperature		15	
Control).....	10		

SAFE INSTALLATION, USE AND SERVICE

The proper installation, use and servicing of this storage tank is extremely important to your safety and the safety of others.

Many safety-related messages and instructions have been provided in this manual and on your own storage tank to warn you and others of a potential injury hazard. Read and obey all safety messages and instructions throughout this manual. It is very important that the meaning of each safety message is understood by you and others who install, use, or service this storage tank.

	<p>This is the safety alert symbol. It is used to alert you to potential personal injury hazards. Obey all safety messages that follow this symbol to avoid possible injury or death.</p>
---	---

	<p>DANGER indicates an imminently hazardous situation which, if not avoided, will result in injury or death.</p>
	<p>WARNING indicates a potentially hazardous situation which, if not avoided, could result in injury or death.</p>
	<p>CAUTION indicates a potentially hazardous situation which, if not avoided, could result in minor or moderate injury.</p>
	<p>CAUTION used without the safety alert symbol indicates a potentially hazardous situation which, if not avoided, could result in property damage.</p>
	<p>NOTICE indicates special instructions on installation, operation, or maintenance that are important but not related to personal injury or property damage.</p>

All safety messages will generally tell you about the type of hazard, what can happen if you do not follow the safety message, and how to avoid the risk of injury.

APPROVALS

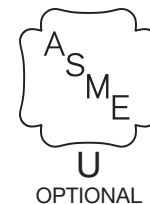

GENERAL SAFETY INFORMATION



WARNING

Read and understand this instruction manual and the safety messages herein before installing, operating or servicing this water heater.

Failure to follow these instructions and safety messages could result in death or serious injury.

This manual must remain with the water heater.

Table 1 links an approximate time-to-burn (for normal adult skin) with a hot water temperature and the resulting burn severity. Use **Table 1** to determine the safest water temperature for hot water use to avoid scalds and burns.

Water Temperature °F (°C)	Time for 1st Degree Burn (Less Severe Burns)	Time for Permanent Burns 2nd & 3rd Degree (Most Severe Burns)
110 (43)	(normal shower temp.)	
116 (47)	(pain threshold)	
116 (47)	35 minutes	45 minutes
122 (50)	1 minute	5 minutes
131 (55)	5 seconds	25 seconds
140 (60)	2 seconds	5 seconds
149 (65)	1 second	2 seconds
154 (68)	instantaneous	1 second

(U.S. Government Memorandum, C.P.S.C., Peter L. Armstrong, Sept. 15, 1978)

This manual is intended to cover installation, operation, and maintenance procedures for storage tanks. Some storage tanks are built to meet customer specifications. Instructions may not be specific to every system.

Most storage tanks are designed for indoor use only, unless otherwise constructed by design specifications. It should be located on a level surface (no more than one-half degree of slope), capable of supporting the total weight of the unit when filled to capacity.

The unit should be mounted to floor following applicable architectural and local code requirements for the specific installation site.

The high quality enamel paint, applied to the outside of the unit, will provide years of protection against corrosion. If it is necessary to clean the outside of the unit, a mild cleaning agent should be used that will not damage the paint.

For all piping connections, the use and / or type of joint compound or sealer on the joints should be determined by referring to local codes, accepted standards, and/or requirements of the installing contractor.

TANK CONSTRUCTION

Storage tanks are pre-engineered and pre-assembled complete with all fittings. They are thoroughly tested to ensure proper

performance from the moment they are installed.

Gallon Capacities: Tanks are available in gallon capacities from 120 to 5000 gallons. Standard construction tanks from 120 to 940 gallons are maintained in regular inventory. Tanks over 1000 gallons are custom manufactured per order.

Tank Orientation: Tanks are available in vertical or horizontal orientation.

Tank Lining: Tanks are available with glass lining as standard or with optional epoxy, cement and black steel.

ASME: All ASME storage tanks are constructed per **ASME Section IV** requirements, or **Section VIII**.

Pressure Rating: Standard tanks are rated at 125 psi. 150 and 160 psi rated tanks are optionally available. Tanks rated at other pressures are available upon request.

Cathodic Protection: All tanks are equipped with magnesium anodes to provide protection against corrosion.

Jacketed Tanks: Jacketed storage tanks have factory-installed insulation and a metal covering. Outdoor rated tanks are available with thick foam insulation with no exposed metal surfaces. All factory-jacketed and insulated storage tanks meet the energy efficiency requirements of the current edition of **ASHRAE 90.1**.

Relief Valve Tapping: For hot water applications, a tapping is provided for the installation of a field supplied ASME safety relief valve.

Temperature and Pressure Gauge (optional): For hot water applications, tanks can be fitted with an optional temperature and pressure gauge.

Tank Stat Opening: All tanks are provided with a tank temperature stat/probe opening that allows proper temperature control of the storage tank.

Bare Tanks: Bare tanks have no factory jacket or insulation.

Water Recirculation Tappings: Storage tanks have two (2) tappings on the tank to provide recirculation piping between the tank and the system. On non-standard tanks, these tappings may be ordered in custom sizes, either threaded or flanged. Extra tappings are also available upon request.

Water Outlet: A water outlet tapping is positioned on the top of the tank for connection to the building system. On non-standard tanks, this tapping may be ordered in custom sizes, either threaded or flanged. Extra tappings are also available upon request.

Drain: A tapping or drain pipe is connected to a low point on the tank for drainage.

Five-Year Limited Tank Warranty: Provides warranty protection against tank failure (see warranty for details).

One-Year Limited Warranty: Parts and accessories (see warranty for details).

⚠️ WARNING

Areas of potential danger.

1. All water lines, joints and valves.
2. All power connections and cables.
3. If the unit has been in operation, allow the water in the heater and all components and surfaces (tank surface, water piping, etc..) to cool before starting the procedure.
4. Assure that all power to associated water heating equipment has been shut off and disconnected before attempting any procedures.
5. Assure that all incoming and outgoing water lines have been shut off at the manual shutoff valves.

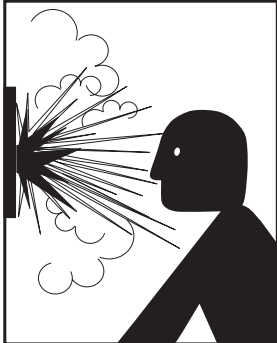

⚠️ WARNING

Explosion Hazard

- Overheated water can cause water tank explosion.
- Properly sized temperature and pressure relief valve must be installed in the opening provided.

⚠️ WARNING

Electrical Shock Hazard



- Turn off power at the branch circuit breaker serving the water heater before performing any service.
- Label all wires prior to disconnecting when performing service. Wiring errors can cause improper and dangerous operation.
- Verify proper operation after servicing.
- Failure to follow these instructions can result in personal injury or death.

INSTALLATION

TRANSPORTING AND UNPACKING THE UNIT

Each storage tank is crated as necessary at the factory. The crating is designed to provide protection for the unit during transportation, and to provide a safe means by which to lift and move the unit with a fork lift or hand truck.

EXAMINING THE UNIT

After the unit has been uncrated and set in place, it should be carefully examined to assure the tank has not been damaged during shipping. If any evidence of damage is detected that could affect the safe operation of the unit, contact your authorized sales representative to report the damage and to receive instructions on how to proceed.

After the unit and all components have been inspected for damage, it is suggested that all optional or independent pressure and temperature control components be checked to assure that they meet or exceed design specifications.

ANCHORING THE UNIT

The unit should be anchored to the floor, following applicable architectural / local code requirements, or accepted standards for the specific installation site. The unit should be installed in a location with sufficient clearance for service and repair.

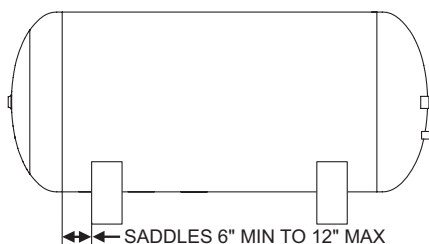

Figure 1. Saddle Clearance

On horizontal tanks, the saddles should be located 6" to 12" from the head / shell seam. Both saddles must be placed using the same dimensions. See *Figure 1*. If there are tapplings in the recommended space or if there are any concerns about proper location for the saddles, please contact the manufacturer.

RECOMMENDED SERVICE CLEARANCES

- 24 inches around the magnesium anode rod(s)
- 24 inches around the manway or hand hole

CONNECTING THE WATER SOURCE

⚠️ WARNING

Before making any connections of water inlet or outlet to the unit, assure that all piping is clean and free of foreign material or scale. This can usually be accomplished by "blowing out" the pipe. Any foreign material or scale entering the unit can adversely affect operation and performance.

The 2 to 3 primary tank tapplings on the lower side of a vertical tank or the 2 tapplings on the bottom of a horizontal tank shall provide recirculation between the tank or building system. See example piping diagrams located on pages 5, 6, 7 and 8.

NOTICE

See the Water Heater's Installation and Operation manual for specific piping diagrams that match the inlet / outlet water tapplings on the tank to the inlet / outlet water tapplings on the water heater. Tapping locations on the water heater may vary by product or manufacturer.

WATER PIPING DIAGRAMS

Before installation of water piping review the following

1. See Mixing Valves on page 9.
2. See Piping The Temperature - Pressure Relief Valve on page 9.

LEGEND



COPPER WATER HEATER WITH VERTICAL TANK - ONE WATER HEATER / VERTICAL STORAGE TANK RECOVERY SYSTEM (ONE TEMPERATURE)

WARNING: THIS DRAWING SHOWS SUGGESTED PIPING CONFIGURATION AND OTHER DEVICES; CHECK WITH LOCAL CODES AND ORDINANCES FOR ADDITIONAL REQUIREMENTS.

MODEL (GWH)	PIPING SIZE "A" (INCH)
400-750	2
1000-2100	2 1/2

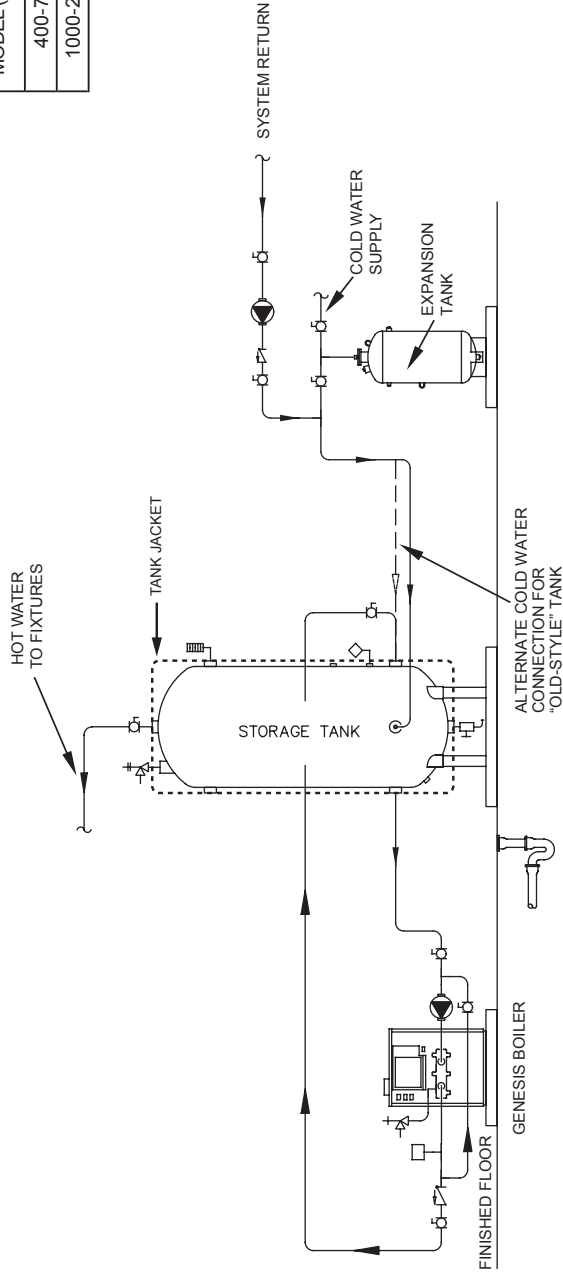

NOTES:

1. Preferred piping method.
2. The temperature and pressure relief valve setting shall not exceed pressure rating of any component in the system.
3. Service valves are shown for servicing water heater. However, local codes shall govern their usage.
4. This piping method is based on 50 equivalent feet of piping. Water heater placement shall be as close as practical to the storage tank.
5. Applications in excess of these recommendations shall require a licensed engineer for design assistance.
6. Pumps are mounted on rear header of each water heater (1000-2100).

WATER PIPING DIAGRAMS

Before installation of water piping review the following

1. See Mixing Valves on page 9.
2. See Piping The Temperature - Pressure Relief Valve on page 9.

XP WATER HEATERS XWH (1000-3400) - ONE WATER HEATER/HORIZONTAL STORAGE TANK RECOVERY SYSTEM (ONE TEMPERATURE)

CAUTION: THIS DRAWING SHOWS SUGGESTED PIPING CONFIGURATION AND OTHER DEVICES; CHECK WITH LOCAL CODES AND ORDINANCES FOR ADDITIONAL REQUIREMENTS.

XP WATER HEATER MODEL (XWH)	WATER HEATER PIPING SIZE (INCH)
1000-1300	2"
1700	2-1/2"
2000	3"
2600	3"
3400	4"

LEGEND

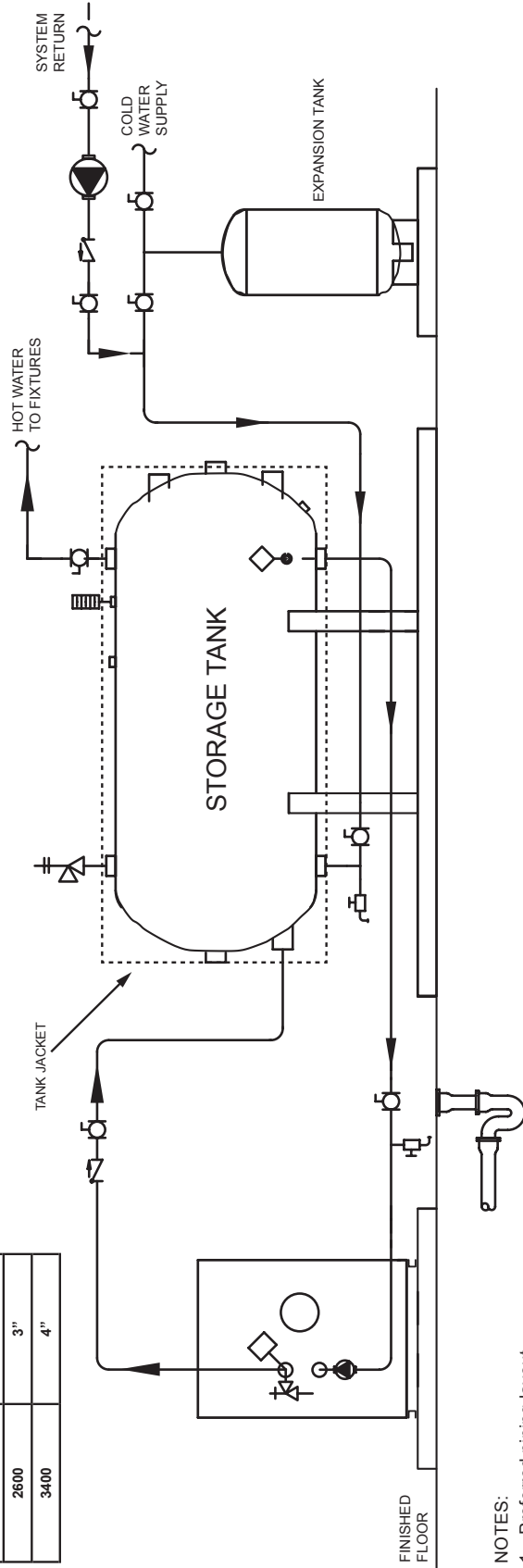
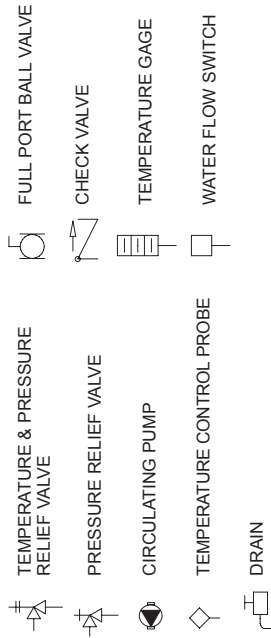

NOTES:

1. Preferred piping layout.
2. The temperature and pressure relief valve setting shall not exceed pressure rating of any component in the system.
3. Service valves are shown for servicing water heater. However, local codes shall govern their usage.
4. The piping method is based on the 50 equivalent feet of piping. Water heater placement shall be as close as practical to the storage tank. Applications in excess of these recommendations shall require a licensed engineer for design assistance.

WATER PIPING DIAGRAMS

Before installation of water piping review the following

1. See Mixing Valves on page 9.
2. See Piping The Temperature - Pressure Relief Valve on page 9.

ONE WATER HEATER, SINGLE TEMPERATURE WITH VERTICAL STORAGE TANK FORCED RECIRCULATION WITH BUILDING RECIRCULATION

WARNING: THIS DRAWING SHOWS SUGGESTED PIPING CONFIGURATION AND OTHER DEVICES; CHECK WITH LOCAL CODES AND ORDINANCES FOR ADDITIONAL REQUIREMENTS.

ANY MATERIAL, COMPONENT OR VENDOR CHANGE MUST HAVE PRIOR APPROVAL BY THE APPLICABLE PRODUCT ENGINEERING DEPARTMENT.

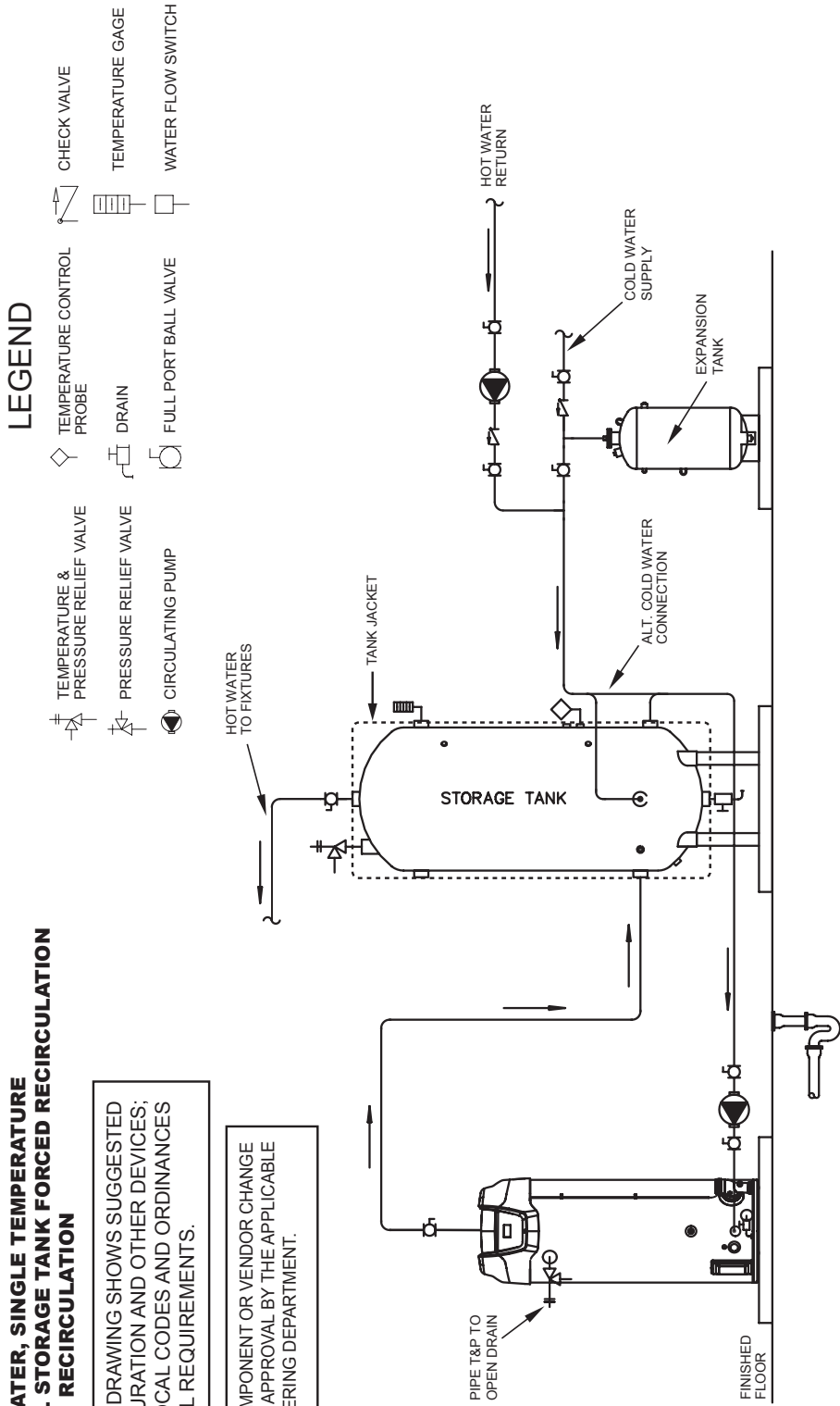

NOTES:

1. Preferred piping method.
2. The temperature and pressure relief valve setting shall not exceed pressure rating of any component in the system.
3. Service valves are shown for servicing unit. However, local codes shall govern their usage.
4. The tank temperature control should be wired to and control the pump between the water heater(s) and the storage tank(s).
5. The water heater's operating thermostat should be set 5 degrees F higher than the tank temperature control.

WATER PIPING DIAGRAMS

Before installation of water piping review the following

1. See Mixing Valves on page 9.
2. See Piping The Temperature - Pressure Relief Valve on page 9.

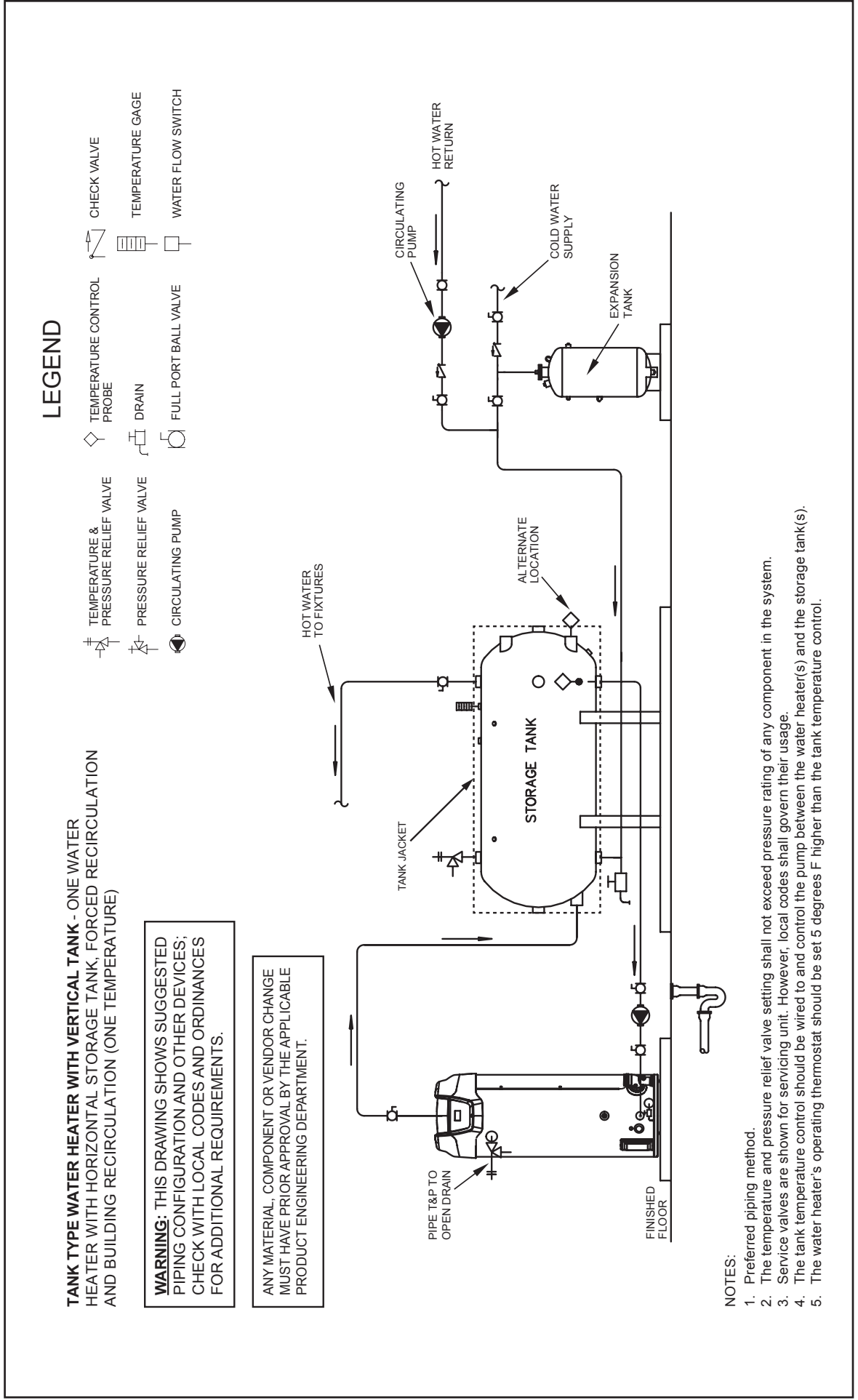

NOTICE

For all piping connections, the use and / or type of joint compound or sealer on the joint should be determined by referring to local codes, accepted practices, or the requirements of the installing contractor.

WATER SUPPLY

The next step in the installation process is to connect the cold water supply to the recirculation piping between the system and the tank(s).

NOTICE

If the cold water supply to the system is equipped with an in-line check valve or backflow preventer, a suitable expansion tank must be installed in the cold water supply line.

WATER OUTLET

The next step in the installation process is to connect the system piping to the water outlet port. The water outlet tapping is located on top of the tank.

A manual shutoff valve should be installed downstream on the water outlet line as an isolation device in case the unit must be disconnected from the system. The shutoff valve should be in the closed position and remain so until the installation is complete.

MIXING VALVE

Field supplied. An anti-scald mixing valve is recommended when storing domestic hot water above 115°F. Scaling might also be a concern. Most mixing valve manufacturers furnish detail piping instructions for properly installing their mixing valves. It is recommended that those instructions be carefully reviewed and followed.

AQUASTAT / REMOTE TEMPERATURE SENSOR (TANK TEMPERATURE CONTROL)

For tanks used in hot water applications, review the controls for the hot water source equipment. Some equipment or systems designs will require an independent aquastat (field supplied) to control the equipment. The tank temperature control should be installed no higher than 1/3 up from the bottom of the tank. In installations using tank type water heaters, the aquastat (remote sensor) controls the recirculation pump (on/off) between the storage tank and the water heater.

PIPING THE TEMPERATURE-PRESSURE RELIEF VALVE

Note: The Temperature-Pressure Relief Valve (T&P Valve) is field supplied and should be sized to have a BTU handling capacity equal to or greater than the total BTUs being used to heat the tank(s).

All storage tanks are equipped with a T&P valve tapping on the tank. The valve should be piped to a discharge line leading to a suitable drain. Piping the pressure relief valve to a suitable drain will prevent both water and heat damage to the unit, as well as

reduce the risk of injury from released heated water. The T&P valve's discharge line must be sized to be the same size as the outlet of the valve and cannot contain any shut off valves, have any uphill runs and the end of the discharge piping cannot be threaded.

CAUTION

Water Damage Hazard

- Temperature-Pressure Relief Valve discharge pipe must terminate at adequate drain.

T&P Valve Discharge Pipe Requirements:

- Shall not be smaller in size than the outlet pipe size of the valve, have any reducers, reducing couplings or any other restrictions.
- Shall not be exposed to freezing temperatures.
- Shall be of material listed for hot water distribution.
- Shall be installed so as to allow complete drainage of both the Temperature-Pressure Relief Valve and the discharge pipe.
- Must terminate a maximum of six inches above a floor drain or external to the building. In cold climates, it is recommended that the discharge pipe be terminated at an adequate drain inside the building.
- Shall not have any valve or other obstruction between the relief valve and the drain.
- Do not cap, block, plug, or insert any valve between the T&P Relief Valve and the end of the discharge pipe.

If a check valve has been installed on the inlet water line, thermal expansion may take place causing build up of excessive pressure when the water is being heated. This expansion will cause the relief valve to open, releasing water to the discharge line. A properly sized expansion tank must be installed to protect the system from water expansion. Check local codes to assure compliance.

WARNING

Do not install a manual shut off valve between the relief valve and the discharge. Doing so could cause serious injury or death if the relief valve released and the manual valve was closed. This would cause excessive buildup of pressure in the storage tank which could result in an explosion.

DRAIN

The tanks' drain connection must be piped to a suitable floor drain. Brass drain cocks are acceptable. A brass full port ball valve is recommended to improve water flow.

COMPLETING INSTALLATION

Installation of the storage tank is now complete. All documentation supplied with the unit should be passed along to maintenance personnel for future reference.

OPERATION

After all installation procedures have been completed, and all water piping to the energy source and power connections have been double checked, the unit is ready for operation. The following Startup Procedure focuses on the storage tank. Check the Installation and Operation Manual of the system for additional startup and shutdown procedures.

TANK PRE-START FLUSH

NOTICE

It is recommended that the tank be flushed before startup in order to clear the vessel of loose particles and material from the installation process. This is strongly recommended for cement lined tanks. To flush the tank, see "Flushing the storage tank" instructions in the "Maintenance" section of this manual.

STARTUP PROCEDURE

1. Assure that all manual shutoff valves are closed.
2. Slowly open the manual shutoff valve on the water supply line and the valves in the recirculation piping. Check to assure that there are not leaks at the valve or any joints. Allow the tank to fill with water. As the tank is filling, hold the relief valve open to allow air to bleed out of the tank. Water faucets at the highest location in the building should also be opened. This will speed the filling process. Make sure the tank is full of water and free of air.
3. Open the manual shutoff valves
4. Turn on the recirculation pump between the system and the tank. After the power to the pump is turned on verify that the pump is working. If the pump is an oil lubricated unit, verify proper oiling.

WARNING

Do not install a manual shut off valve between the relief valve and the discharge. Doing so could cause serious injury or death if the relief valve released and the manual valve was closed. This would cause excessive buildup of pressure in the storage tank which could result in an explosion.

5. Follow the Startup procedure for the system. For hot water applications, adjust the operating temperature control to the desired operating temperature and set the safety high limit.
6. With the system running, carefully re-inspect water recirculation piping and the tank water outlet for signs of leakage.
7. For hot water applications, after the unit has reached its operating temperature, after the unit has reached operating temperature, re-inspect all joints for signs of leakage. In addition, check all gauges and controls to verify that the water temperature and pressure are within design specifications.
8. The unit is now ready for normal operation.

SHUTDOWN PROCEDURE

1. Turn off all power to the circulating pump and the system source controls.
2. Close all valves in the system in the following order:
 - the water outlet line;
 - the recirculation water piping
3. Relieve the pressure where possible.
4. After the system has cooled, drain the unit by opening the tank drain valve and holding the relief valve in the open position. This will prevent the formation of a vacuum and increase the drainage flow.
5. Proceed with the required maintenance or repairs.
6. After performing the required maintenance or repairs, return the unit to operation by following the Startup Procedure.

INSPECTION

The following table summarizes the recommended time intervals for inspections of the tank, components, water piping and power connections.

Table 2. Recommended Inspections					
To Be Inspected	Time Interval				
	Per Manufacturer Specs	Weekly	Monthly	Quarterly	Annually
Circulating Pump	✓				
Gauges - Pressure & Temperature				✓	
Lines - Inlet, Outlet, & Return				✓	
Pressure Relief Valve	✓				
Shutoff Valves - Manual		✓			
Temperatures - Water & Operating				✓	
Thermometer			✓		
Magnesium Anode Rods					✓
Interior for Sediment or Scale					✓
Flush Tank at Six-Month (6) Intervals			✓		

MAINTENANCE

A new tank installation should have a regular inspection program set up. The first inspection should be within the first three months of operation. Once the tendency to accumulate sediment has been established, the inspection program can be modified to suit the water conditions. Typical inspection programs flush the tank at six-month intervals and clean the tank in yearly intervals.

Deliming solvents or acid type flush agents are not recommended for use in lined storage tanks. These chemical cleaners are usually designed for use in non-potable systems such as heating boilers. These chemicals may be aggressive and cause damage to the tank lining and deteriorate the magnesium anodes supplied in glass-lined storage tanks.

WARNING

Hot water will be released under pressure. Avoid contact with the hot discharge water to prevent the risk of severe scald injury.

FLUSHING THE STORAGE TANK

Since mineral accumulation occurs in an un-fired tank it will be in a soft sediment form. This soft sediment can be removed by a regular flushing of the lower portion of the tank.

To flush the tank, follow these steps:

1. Turn off electrical power to the circulating pump and any other tank accessories.
2. Close the valve on the water outlet on top of the storage tank.
3. Ensure that the drain located on the bottom of the tank is routed to a floor drain with adequate capacity to allow the tank to be flushed.
4. Open the drain valve and allow the inlet water supply water to flush the soft sediment out the bottom of the storage tank. In Hot water applications, use extreme caution, as the water exiting the tank drain may be very hot. Avoid contact with the hot discharge water to prevent the risk of severe scald injury.
5. Observe the color of the water initially discharged from the tank drain. This water will generally be milky or slightly discolored by the sediment discharge. Allow the drain to run until the water runs clear.
6. Close the drain valve on the tank.
7. Open the water outlet valve on top of the tank.
8. Open an adjacent water tap to purge any air that may have entered the storage tank during the draining process. Close the water tap if no air discharge is observed.
9. Turn on electric power to the circulating pump and other electrical components if necessary.
10. Observe tank and piping to ensure all components are functioning properly.

CLEANING THE STORAGE TANK

The mineral accumulation in an un-fired tank will be in a soft sediment form that can be removed by a regular cleaning of the lower portion of the tank. Many tanks will have a hand hole or a larger manway to allow access to the interior of the tank for

complete removal of accumulated sediment. An access opening to remove the manway or hand hole is provided in the exterior jacket. The sheetmetal jacket components are removed with hand tools. The opening will be in the bottom portion of a vertical tank and on the end of a horizontal tank. See **Figure 2** and **Figure 3** below.

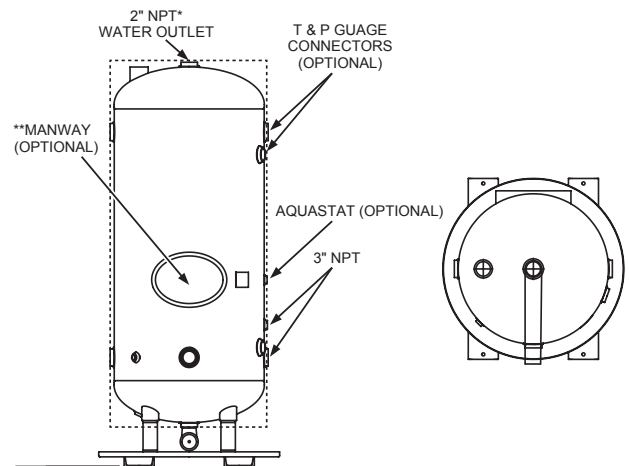

**Manway standard on cement and required on tanks with bundles 48" and larger.

Figure 2. Vertical Tank

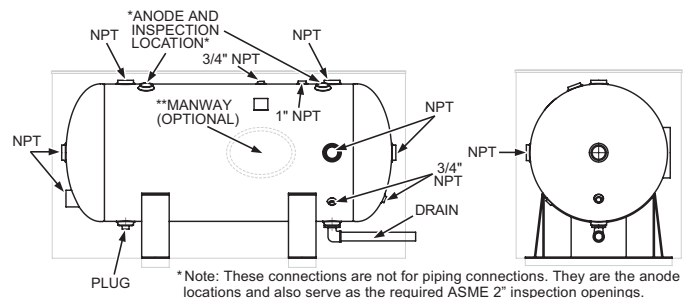

*Note: These connections are not for piping connections. They are the anode locations and also serve as the required ASME 2" inspection openings.

Figure 3. Horizontal Tank

NOTICE

For this procedure, a new manway gasket or hand hole gasket should be acquired before beginning this procedure.

1. Turn off electrical power to the circulating pump and other electrical components if necessary.
2. Close the valve on the water outlet on top of the storage tank and the water supply to the system.
3. Ensure that the drain located on the bottom of the tank is routed to a floor drain with adequate capacity to allow the tank to be drained.
4. Open the drain valve and open a vent to allow the air to enter the tank (manually opening the relief valve will usually accomplish this). In hot water applications use extreme caution, as the water exiting the tank drain may be very hot. Avoid contact with the hot discharge water to prevent the risk of severe scald injury.
5. Allow the tank to drain completely.
6. Remove the jacket cover over the manway or hand hole. Remove the bolt(s) securing the tank access opening. Use a flashlight to observe the sediment collected in the tank.

7. Use hand tools to remove all sediment from the interior of the tank. Use care not to damage the interior lining of the storage tank.
8. Use a water hose to flush the remaining sediment from the interior surfaces of the tank and ensure that all debris is removed. Scale or sediment allowed to reach the potable system can foul valves, pumps, strainers, and other water fixtures. Ensure that the tank interior is clean before refilling the vessel.
9. Install a new gasket on the manway or hand hole to prevent any possible leaks. Tighten the gasket properly to prevent leaks.

CAUTION

Over tightening can result in cutting the gasket and allowing a water leak to occur.

10. Replace the jacket cover over the manway or hand hole.
11. Close the drain and open the water supply and water outlet. If the relief valve was used for a vent ensure that it is now closed. Open the closest water valve to allow the air in the tank to vent as water enters the vessel. Close the valve opened for a vent when water flows from the valve.
12. Check the manway or hand hole and all related piping for any water leaks.
13. Turn on electric power to the circulating pump and other electric components if necessary.
14. Turn on the system.
15. Open the valves in the water source recirculation piping.
16. Observe tank and piping to ensure all components are functioning properly.

MAGNESIUM ANODE ROD INSPECTION

Glass lined storage tanks have a magnesium anode(s) to provide cathodical protection of the lining and minimize corrosion. Aggressive water conditions in some areas of the country may accelerate the deterioration of the anode(s). The anode(s) should be periodically removed and inspected to determine if replacement is necessary.

The tank must be valved off from the system and fully drained to remove an anode for inspection. Anodes are supplied in threaded fittings on the top head of small vertical storage tanks. Top mounted anodes may be accessed by removing the plastic plugs in the jacket top. Medium sized tanks with round jackets provide an opening for individual anode rod access.

Large vertical storage tanks and horizontal storage tanks have multiple anodes installed in threaded tapings along the length of the tank. These anodes may be accessed by removing a jacket panel and/or corner post corresponding to the mounting point of the anodes. See *Figure 4* and *Figure 5*. Adequate service clearance is required to allow removal of an anode. Field insulated tanks should make considerations for access to the anode rods.

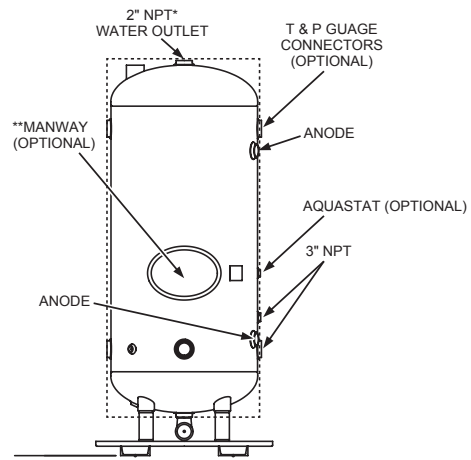

**Manway standard on cement and required on tanks with bundles 48\" and larger.

Figure 4. Vertical Tank Anode Inspection Locations

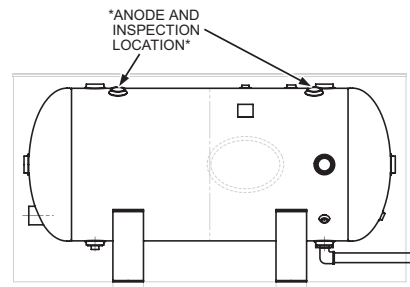

Figure 5. Horizontal Tank Anode Inspection Locations

NOTICE

Anode rods showing excessive decomposition may indicate electrolysis. An earth ground should be attached to the vessel to divert stray current and prevent tank damage.

WATER PIPING AND VALVE REPLACEMENT

If any of the inlet, outlet, return lines, or shutoff valves are damaged and must be replaced, follow the steps outlined in this section.

WARNING

The combination of electricity and water can pose a very dangerous situation. Turn off / disconnect all electric power before attempting any maintenance procedure.

1. Follow Steps 1 through 5 of the *Shutdown Procedure* (page 11) to take the system source off-line before attempting to replace damaged lines or shutoff valves.

WARNING

While it might seem feasible to replace inlet and outlet water lines, and shutoff valves without shutting down the entire unit, it is not advised. Unless the unit is completely shut down, and the water and the energy source are isolated from the system, failure of a manual shutoff valve during the replacement process could result in serious injury.

2. Make certain that the water source recirculation valves and water outlet valves have been shut off; that the tank has been completely drained; that the pressure has been bled from both the water and energy source systems; and that all components and surfaces have cooled.
3. Carefully break the joint between the unit and the line or valve to be replaced.
4. Remove the section of the line or valve to be replaced.
5. Replace the damaged section of the line or valve.
6. Reconnect the line or valve to the unit. Follow recommendations contained in the manufacturer's documentation, local codes, or accepted contractor practices as to the use and /or type of joint compound or sealer at the connections.
7. Follow the *Startup Procedure* (page 11) to place unit back on-line. Carefully check all connections for any sign of leakage.

TEMPERATURE / PRESSURE GAUGE (OPTIONAL) REPLACEMENT

If the temperature / pressure gauge for the water tank is not functioning correctly and must be replaced, follow the procedure outlined in the next four steps.

WARNING

The combination of electricity and water can pose a very dangerous situation. Turn off / disconnect all electric power before attempting any maintenance procedure.

1. Follow Steps 1 through 5 of the *Shutdown Procedure* (page 11) to take the unit off-line before attempting to replace the water temperature / pressure gauge.
2. Carefully unscrew the water temperature / pressure gauge from the port in the tank.
3. Install the new gauge into the port in the tank in place of the old one removed in Step 2. Follow recommendations contained in the manufacturer's documentation, local codes, or accepted contractor practices as to the use of joint compound or sealer at the connections.
4. Follow the steps in *Startup Procedure* (page 11) to place the unit back on-line. Carefully check all connections for any sign of leakage.

